

FY60PC + MW60SP

Piano in cristallo extra_light verniciato da cm 100 a 200 per lavabo Miniwash 60 sottopiano (staffe di fissaggio incluse)

Complementi: Lavabo Miniwash 60 (MW60SP)
 Specchi e Lampade Make-Up
 Specchi Simple
 Specchio Hot/Cold (SPHC)
 Specchio Left/Right (SPLR)
 Specchi Line (BASC20 - BASC30 - BASC40)
 Rubinetti lavabo linea ONE - NOKÉ - FOLD - SI - X1
 Accessori linea TWO - HOOP - NOKÉ - FOLD

Accessori tecnici: Sifone cromo (SIFL/CR) - Sifone telescopico cromo (SIFL066)
 Piletta Stop & Go (PLSG)
 Piletta Stop & Go in ceramica (PLCE)
 Set 2 pezzi rubinetto filtro cromo (RF026)



vista zenitale / zenital view

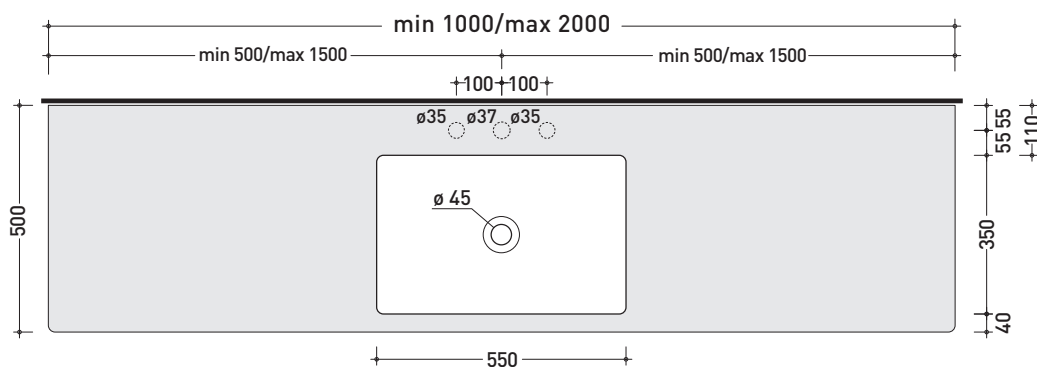

vista frontale / frontal view

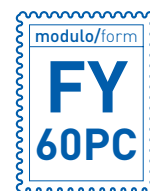
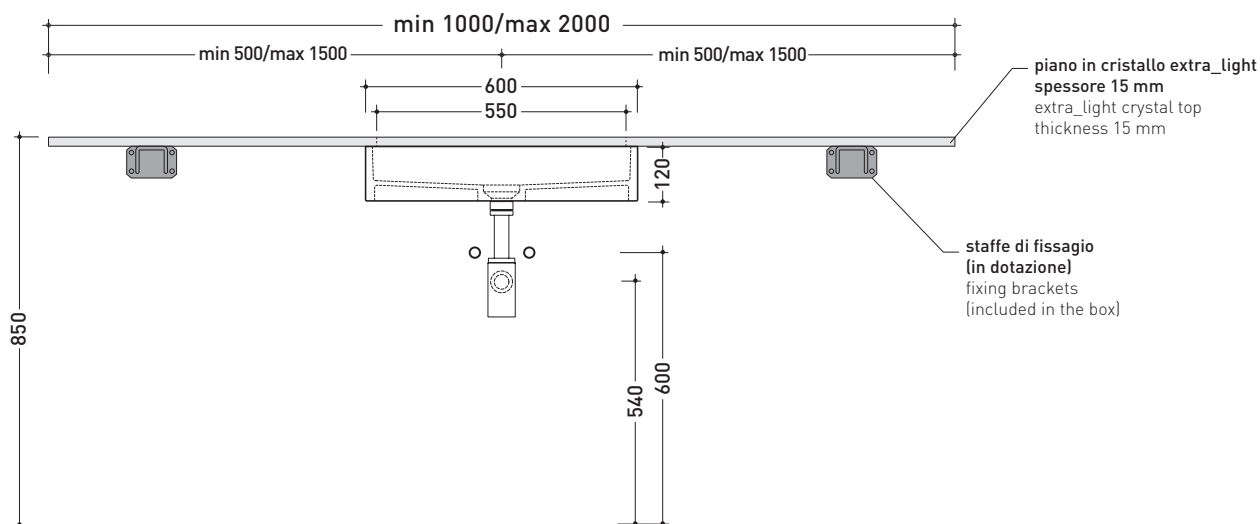

RIFERIMENTO
 MODULO ORDINE
 OBBLIGATORIO

dimensioni in mm

CRISTALLO: finiture lucide



bianco



nero

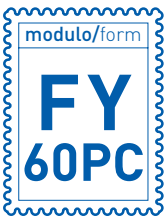

MODULO PER LA REALIZZAZIONE DEI PIANI IN CRISTALLO **FLY** A MISURA PER ART. **MW60SP**
FLY CUSTOMIZED CRYSTAL SHELVES FOR ART. MW60SP FORM



E' obbligatorio fotocopiare questa pagina, compilarla con cura e allegarla all'ordine.
 It is compulsory to photocopy this page, carefully fill in and attach to the order.

➔➔ **1** DETTAGLI ORDINE / ORDER DETAILS

ordinante - buyer _____ cliente - client _____

ordine - order n: _____ data - date: _____ ref.: _____

annotazioni - notes _____

➔➔ **2** SCELTA ARTICOLO / ITEM CHOICE

E' importante consultare prima la scheda tecnica relativa
 It's important to consult before the technical detail

art. **FY60PC**
 mensola / shelf da / from **100 a / to 200 cm**

➔➔ **3** SCELTA COLORE / COLOUR SELECTION

CRISTALLO EXTRA_LIGHT
 EXTRA_LIGHT CRYSTAL

bianco - white nero - black

➔➔ **4** SCELTA DETTAGLI / DETAIL SELECTION

FORI RUBINETTERIA / TAP HOLES

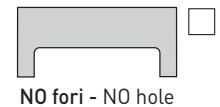
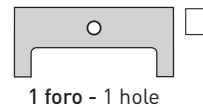
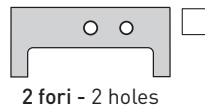
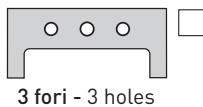

➔➔ **5** SCELTA MISURE / MEASURES

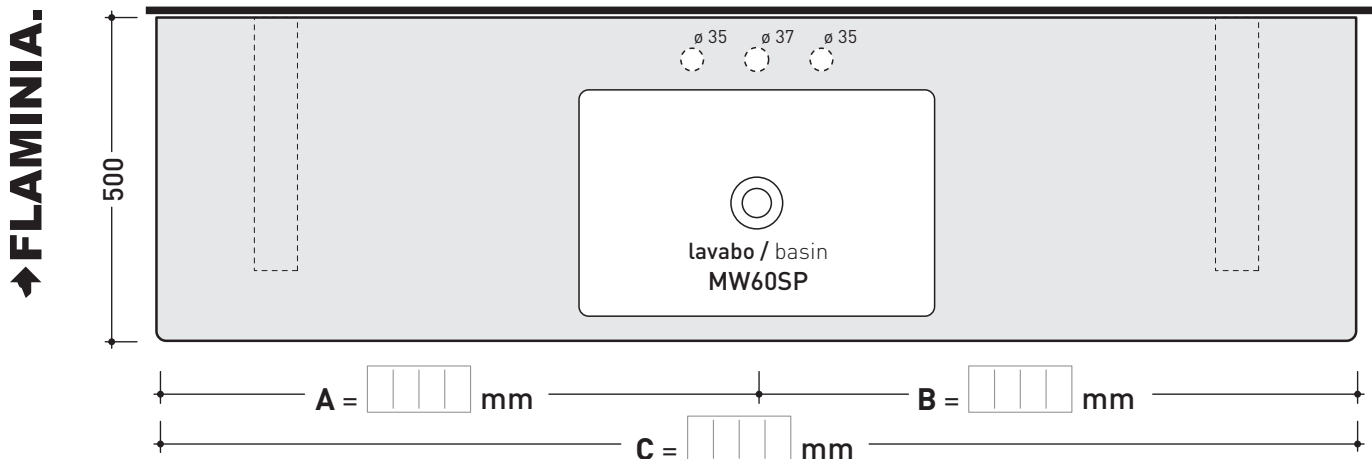

- **A** = misura interasse lavabo da sinistra / left distance of basin.
- **B** = misura interasse lavabo da destra / right distance of basin.
- **C** = misura totale del piano / total length of the shelf.
- verificare sempre che / verify that: **A + B = C**.

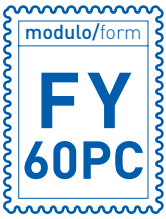

MODULO PER LA REALIZZAZIONE DEI PIANI IN CRISTALLO **FLY** A MISURA PER DOPPIO ART. **MW60SP**
FLY CUSTOMIZED CRYSTAL SHELVES FOR DOUBLE ART. MW60SP FORM



E' obbligatorio fotocopiare questa pagina, compilarla con cura e allegarla all'ordine.
 It is compulsory to photocopy this page, carefully fill in and attach to the order.

➔➔ **1** **DETTAGLI ORDINE / ORDER DETAILS**

ordinante - buyer _____ cliente - client _____

ordine - order n: _____ data - date: _____ ref.: _____

annotazioni - notes _____

➔➔ **2** **SCelta ARTICOLO / ITEM CHOICE**

E' importante consultare prima la scheda tecnica relativa
 It's important to consult before the technical detail

art. **FY60PC**
 mensola / shelf da / from **180 a / to 200 cm**

➔➔ **3** **SCelta COLORE / COLOUR SELECTION**

CRISTALLO EXTRA_LIGHT
EXTRA_LIGHT CRYSTAL

bianco - white nero - black

➔➔ **4** **SCelta DETTAGLI / DETAIL SELECTION**

FORI RUBINETTERIA / TAP HOLES

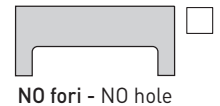
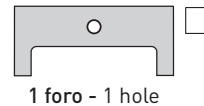
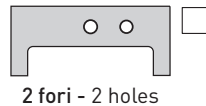
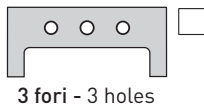

➔➔ **5** **SCelta MISURE / MEASURES**

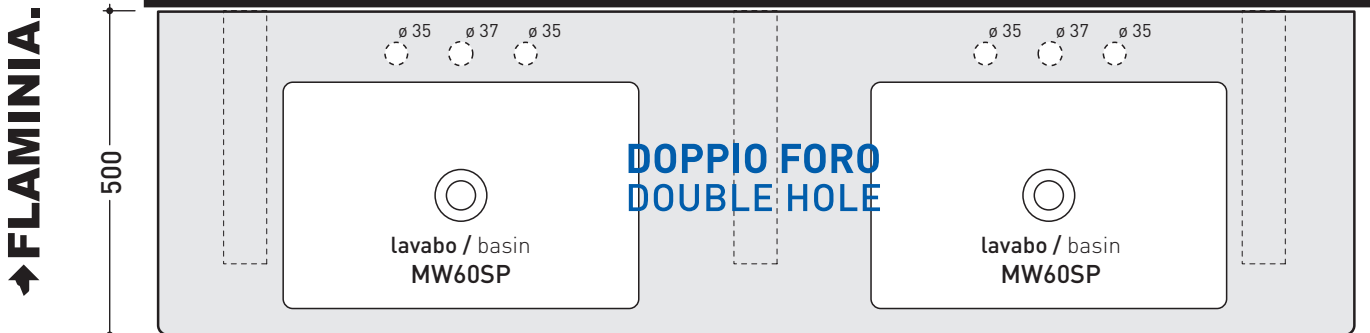
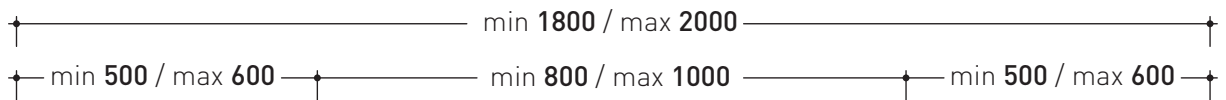

- **A** = misura interasse lavabo da sinistra / left distance of basin.
- **B** = misura interasse lavabi / distance between basins.
- **C** = misura interasse lavabo da destra / right distance of basin.
- **D** = misura totale del piano / total length of the shelf.
- verificare sempre che / verify that: **A + B + C = D.**