

design **FLAMINIA DESIGN TEAM**

2010

## F6MW suitable for Miniwash (MWL40/48/60/75 - MW60/75PR)

Shelf from 80 to 250 x 46 x h 10 cm suitable for countertop basins  
Miniwash (fixing brackets included)

- Complements:
- Make-Up mirrors and lamps
  - App mirros
  - Simple mirros
  - Hot/Cold mirror (SPHC)
  - Left/Right mirror (SPLR)
  - Line mirrors (BASC20 - BASC30 - BASC40)



Tap holes are not made on this article by Flaminia

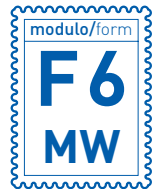
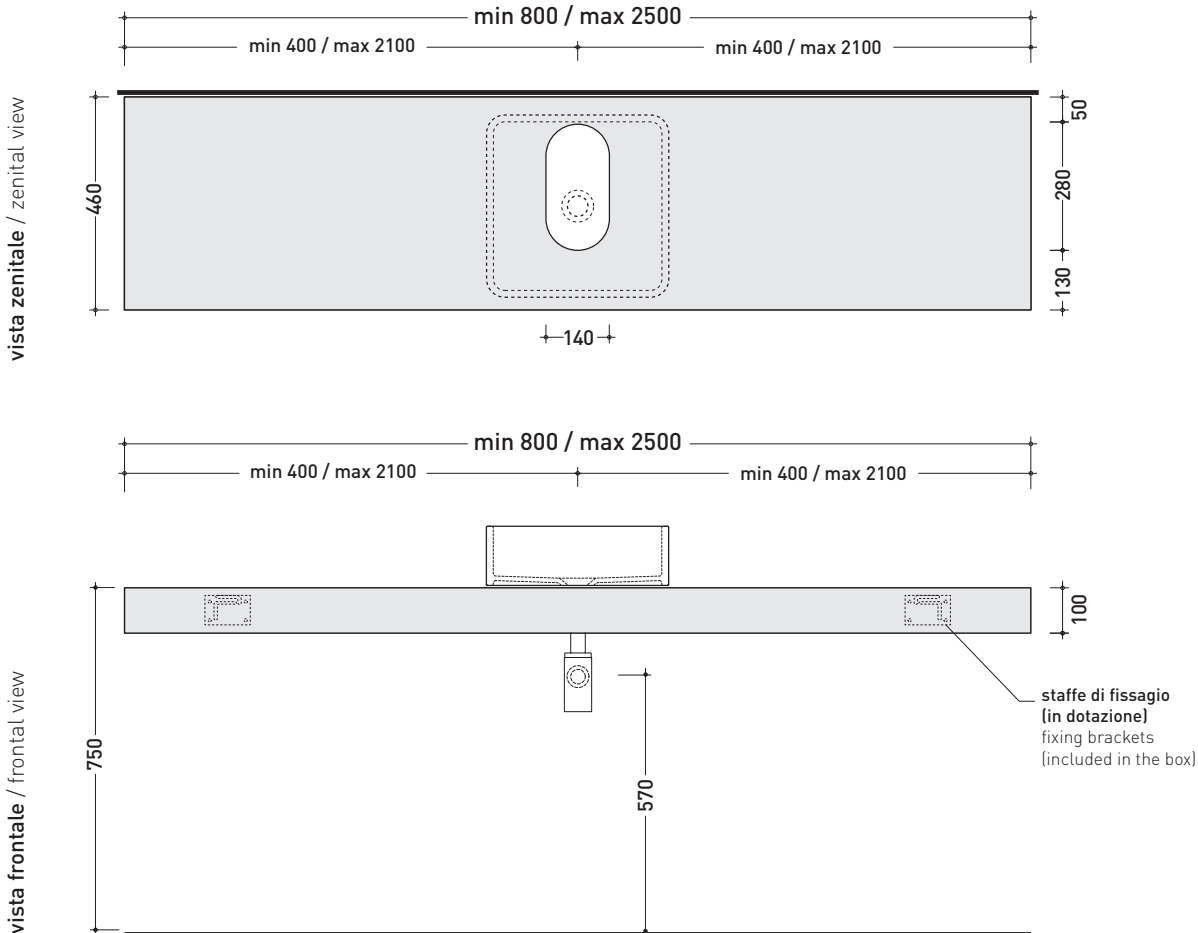

REFERENCE TO  
THE COMPULSORY  
ORDER FORM

sizes in mm

**PIETRALUCE:** glossy finish



**matt finish**

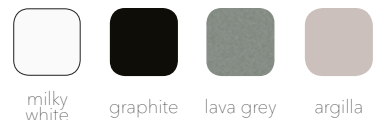

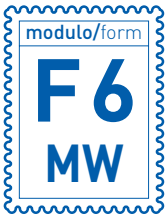

MODULO PER LA REALIZZAZIONE DELLE MENSOLE **FORTY6** A MISURA PER ART. **MWL40-48-60-75 / MW60-75PR**

**FORTY6** CUSTOMIZED SHELVES FOR ART. **MWL40-48-60-75 / MW60-75PR** FORM



**E' obbligatorio fotocopiare questa pagina, compilarla con cura e allegarla all'ordine.**  
It is compulsory to photocopy this page, carefully fill in and attach to the order.

## ➔➔ 1 DETTAGLI ORDINE / ORDER DETAILS

ordinante - buyer		cliente - client	
ordine - order n:	data - date:	ref.:	
annotazioni - notes			

## ➔➔ 2 SCELTA ARTICOLO / ITEM CHOICE

E' importante consultare prima la scheda tecnica relativa  
It's important to consult before the technical detail

art. **F6MW**  
mensola / shelf da / from 80 a / to 250 cm

## ➔➔ 3 SCELTA MATERIALE / MATERIAL SELECTION

PIETRALUCE lucida / glossy		PIETRALUCE opaco / mat	
<input type="checkbox"/> bianco - white	<input type="checkbox"/> sabbia - sand	<input type="checkbox"/> argilla - argilla	<input type="checkbox"/> gr. lava - lava grey
<input type="checkbox"/> grigio - grey	<input type="checkbox"/> nero - black	<input type="checkbox"/> latte - milky white	<input type="checkbox"/> grafite - graphite
<input type="checkbox"/> beige - beige	<input type="checkbox"/> rosso cuoio - red		
<input type="checkbox"/> blu ultram. - marine blue			

## ➔➔ 4 SCELTA MISURE / MEASURES

➔ **FLAMINIA.**

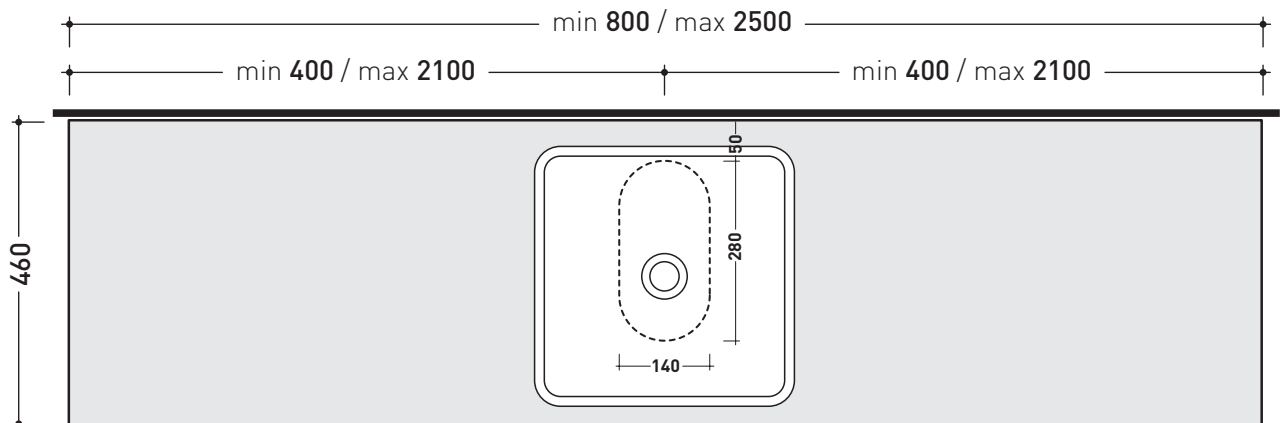

lavabo / basin  
MWL40 - MWL48 - MWL60 - MWL75 - MW60PR - MW75PR

A =	<input type="text"/>	mm	B =	<input type="text"/>	mm
C =			<input type="text"/>	mm	

• **A** = misura interasse lavabo da sinistra / left distance of basin.    • **C** = misura totale della mensola / total length of the shelf.  
• **B** = misura interasse lavabo da destra / right distance of basin.    • verificare sempre che / verify that: **A + B = C**.

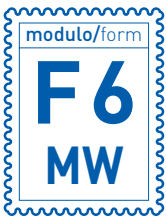

MODULO PER LA REALIZZAZIONE DELLE MENSOLE **FORTY6** A MISURA PER DOPPIO ART. **MWL40-48-60-75 / MW60-75PR**  
**FORTY6 CUSTOMIZED SHELVES FOR DOUBLE ART. MWL40-48-60-75 / MW60-75PR FORM**

 **E' obbligatorio fotocopiare questa pagina, compilarla con cura e allegarla all'ordine.**  
 It is compulsory to photocopy this page, carefully fill in and attach to the order.

➔➔ **1** DETTAGLI ORDINE / ORDER DETAILS

ordinante - buyer		cliente - client	
ordine - order n:	data - date:	ref.:	
annotazioni - notes			

➔➔ **2** SCELTA ARTICOLO / ITEM CHOICE

E' importante consultare prima la scheda tecnica relativa  
 It's important to consult before the technical detail

**art. F6MW**  
 mensola / shelf da / from 165 a / to 250 cm

➔➔ **3** SCELTA MATERIALE / MATERIAL SELECTION

PIETRALUCE lucida / glossy		PIETRALUCE opaco / mat	
<input type="checkbox"/> bianco - white	<input type="checkbox"/> sabbia - sand	<input type="checkbox"/> argilla - argilla	<input type="checkbox"/> gr. lava - lava grey
<input type="checkbox"/> grigio - grey	<input type="checkbox"/> nero - black	<input type="checkbox"/> latte - milky white	<input type="checkbox"/> grafite - graphite
<input type="checkbox"/> beige - beige	<input type="checkbox"/> rosso cuoio - red		
<input type="checkbox"/> blu ultram. - marine blue			

➔➔ **4** SCELTA MISURE / MEASURES

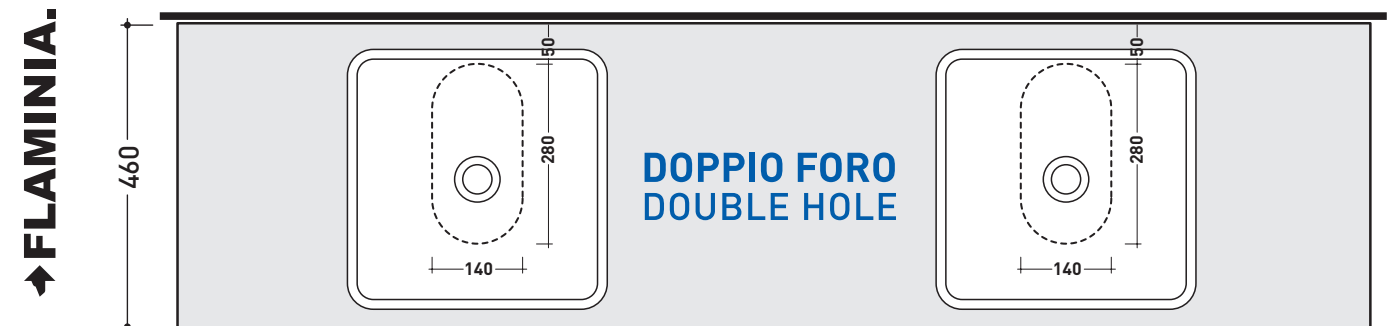
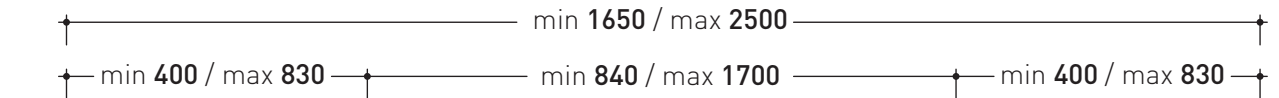

lavabo / basin MWL40 - MWL48 - MWL60 - MWL75 - MW60PR - MW75PR		lavabo / basin MWL40 - MWL48 - MWL60 - MWL75 - MW60PR - MW75PR	
A = <input type="text"/> mm	B = <input type="text"/> mm	C = <input type="text"/> mm	D = <input type="text"/> mm

- A = misura interasse lavabo da sinistra / left distance of basin.
- B = misura interasse lavabi / distance between basins.
- C = misura interasse lavabo da destra / right distance of basin.
- D = misura totale della mensola / total length of the shelf.
- verificare sempre che / verify that: **A + B + C = D.**