

# Make-up

design **PAOLA NAVONE**

2011

➔ **FLAMINIA.**

## MKL80 Make-up 80

Modular ceramic hanging lamp 80 cm (BULB NOT INCLUDED)

Package dim. 82 x 22 x 20 cm | Weight 3 kg | Pz. Pallet n° -

## MKL120 Make-up 120

Modular ceramic hanging lamp 120 cm (BULB NOT INCLUDED)

Package dim. 121 x 22 x 20 cm | Weight 3,5 kg | Pz. Pallet n° -

## MKL160 Make-up 160

Modular ceramic hanging lamp 160 cm (BULB NOT INCLUDED)

Package dim. 160 x 22 x 20 cm | Weight 4 kg | Pz. Pallet n° -



CE

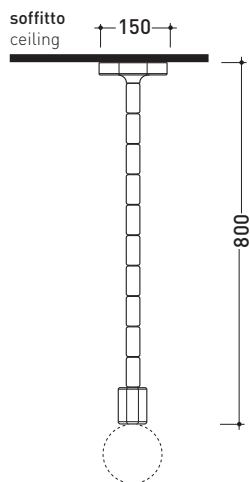

vista frontale / frontal view

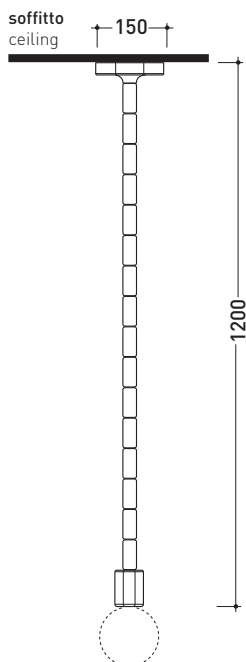

vista frontale / frontal view

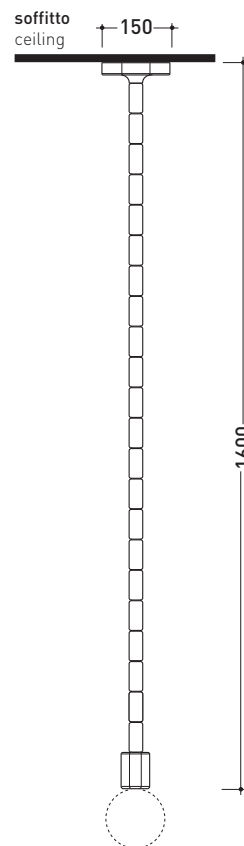

vista frontale / frontal view

sizes in mm

Please consider a 2% tolerance on indicated measurements

CERAMIC: glossy finish

### ELECTRICAL CHARACTERISTICS

- type of lamp: incandescent lamp with E27 cap
- class: I
- Ip code: IP20
- rated power: 24 W



white

<http://www.ceramicaflaminia.it/en/products/298-make-up>

©ceramicaflaminiaspa - All rights reserved. Unauthorized copying, publication, reproduction as well as partial reproduction are prohibited

march 2017



design **PAOLA NAVONE**

2011

## MKLP

Ceramic wall lamp (BULBS NOT INCLUDED)

Complements: **Make-Up mirrors** (MKS100 - MKS50 - MKS501)

Package dim. **55 x 22 x 17 cm** | Weight **5 kg** | Pz. Pallet n° -



CE

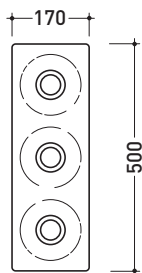

vista frontale / frontal view

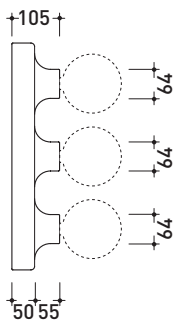

vista laterale / lateral view



sezione longitudinale / section

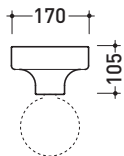

vista zenitale / zenital view

sizes in mm

Please consider a 2% tolerance on indicated measurements

**CERAMIC:** glossy finish



white

**ELECTRICAL CHARACTERISTICS**

- type of lamp: incandescent lamp with E27 cap
- class: I
- Ip code: IP20
- rated power: 3 x 24 W

# Make-up

design **PAOLA NAVONE**

2011

➔ **FLAMINIA.**

## MKS100

Reversible mirror 150x100 cm (horizontal and vertical installation)

Complements: **Make-Up wall lamp** (MKLP)  
**Make-Up benches** (MKP150 - MKP180)

Package dim. 158 x 106 x 7 cm | Weight 20 kg | Pz. Pallet n° -



CE

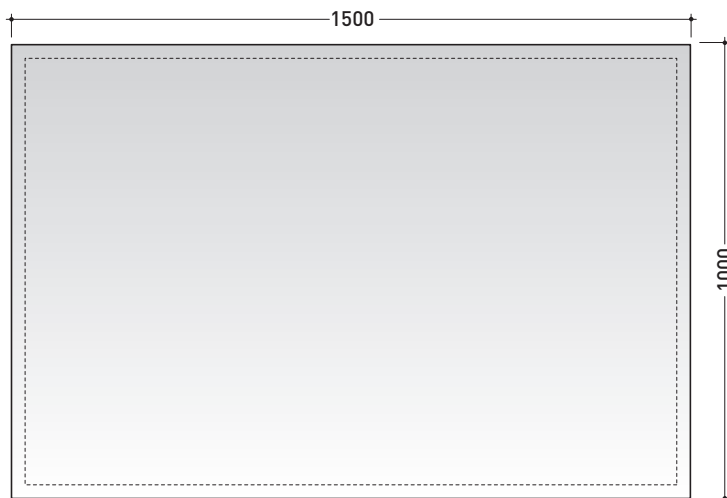

vista frontale / frontal view



vista laterale / lateral view



vista zenitale / zenital view

sizes in mm

Please consider a 2% tolerance on indicated measurements

<http://www.ceramicaflaminia.it/en/products/298-make-up>

©ceramicaflaminiaspa - All rights reserved. Unauthorized copying, publication, reproduction as well as partial reproduction are prohibited

march 2017



# Make-up

design **PAOLA NAVONE**

2011

➔ **FLAMINIA.**

## MKS50

Reversible mirror 150x50 cm (horizontal and vertical installation)

Complements: **Make-Up wall lamp** (MKLP)  
**Make-Up benches** (MKP150 - MKP180)

Package dim. 158 x 57 x 7 cm | Weight 12 kg | Pz. Pallet n° -



CE

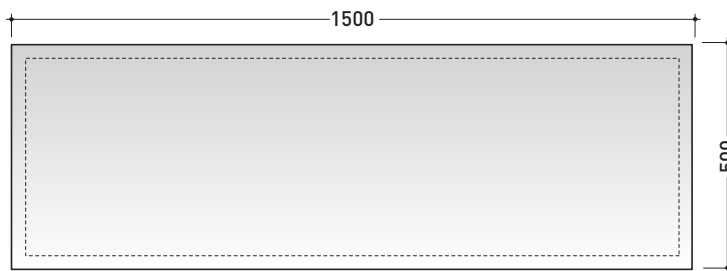

vista frontale / frontal view



vista laterale / lateral view



vista zenitale / zenital view

sizes in mm

Please consider a 2% tolerance on indicated measurements

<http://www.ceramicaflaminia.it/en/products/298-make-up>

©ceramicaflaminiaspa - All rights reserved. Unauthorized copying, publication, reproduction as well as partial reproduction are prohibited

march 2017



# Make-up

design **PAOLA NAVONE**

2011

## MKS501

Reversible mirror 100x50 cm (horizontal and vertical installation)

Complements: **Make-Up wall lamp** (MKLP)  
**Make-Up benches** (MKP150 - MKP180)

Package dim. 109 x 56 x 7 cm | Weight 10 kg | Pz. Pallet n° -

➔ **FLAMINIA.**



CE

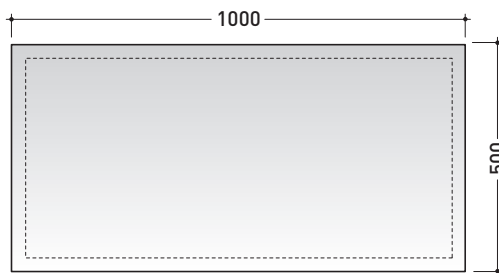

vista frontale / frontal view



vista laterale / lateral view



vista zenitale / zenital view

sizes in mm

Please consider a 2% tolerance on indicated measurements

<http://www.ceramicaflaminia.it/en/products/298-make-up>

©ceramicaflaminiaspa - All rights reserved. Unauthorized copying, publication, reproduction as well as partial reproduction are prohibited

march 2017



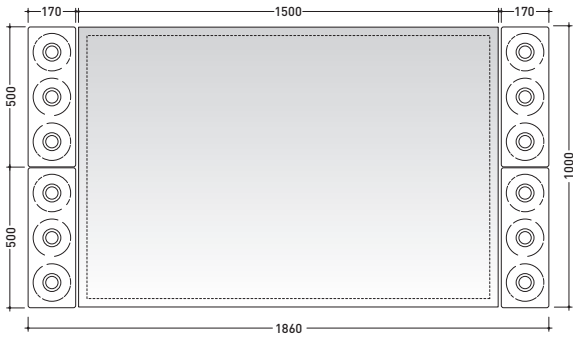

vista frontale / frontal view  
4pcs art. MKLP + art. MKS100

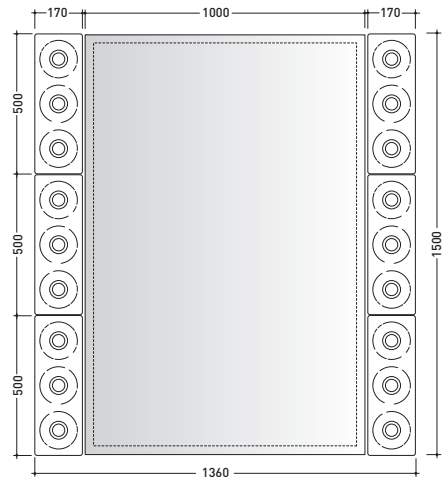

vista frontale / frontal view  
6pcs art. MKLP + art. MKS100

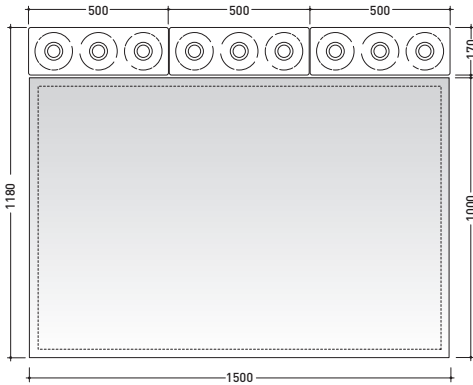

vista frontale / frontal view  
3pcs art. MKLP + art. MKS100

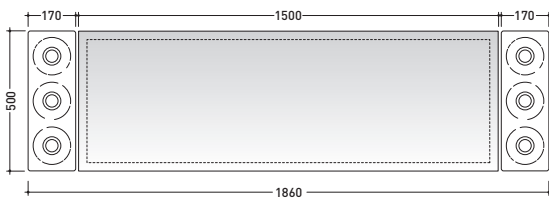

vista frontale / frontal view  
2pcs art. MKLP + art. MKS50

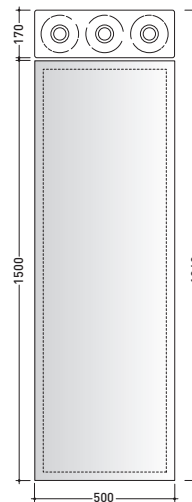

vista frontale / frontal view  
1pcs art. MKLP + art. MKS50

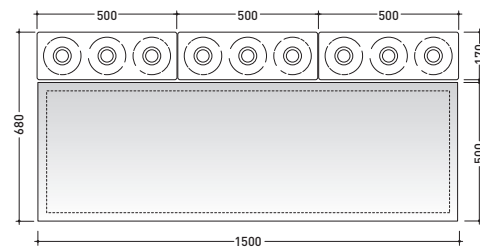

vista frontale / frontal view  
3pcs art. MKLP + art. MKS50

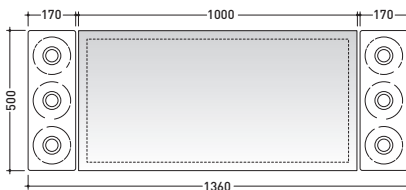

vista frontale / frontal view  
2pcs art. MKLP + art. MKS501

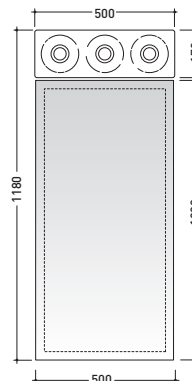

vista frontale / frontal view  
1pcs art. MKLP + art. MKS501

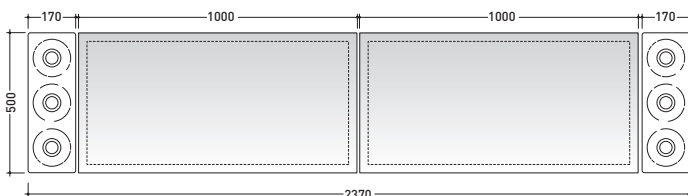

vista frontale / frontal view  
2pcs art. MKLP + 2pcs art. MKS501

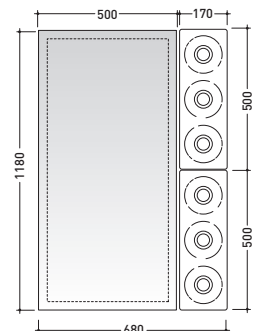

vista frontale / frontal view  
2pcs art. MKLP + art. MKS501

# Make-up

➔ **FLAMINIA.**

design **PAOLA NAVONE**

2011

## MKP150 Make-up 150

Bench 150x56 cm with satined steel structure and Matrix or Pietraluce top

Complements: **Make-Up mirrors** (MKS100 - MKS50 - MKS501)

Package dim. Pietraluce	147 x 60 x 7 cm	Weight 80 kg	Pz. Pallet n° -
Package dim. Matrix	160 x 64 x 15 cm	Weight 70 kg	Pz. Pallet n° -

Basin or tap holes are not made on this article by Flaminia

CE

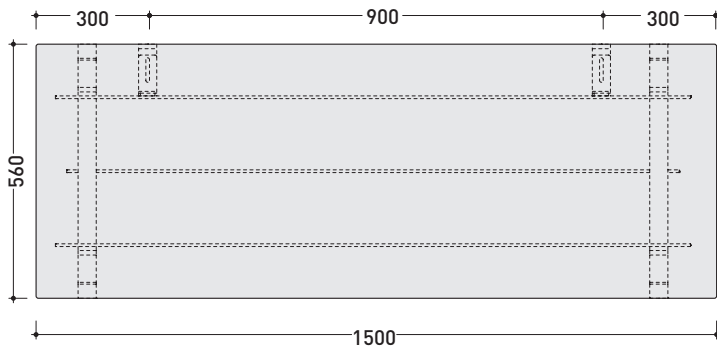

vista zenitale / zenital view

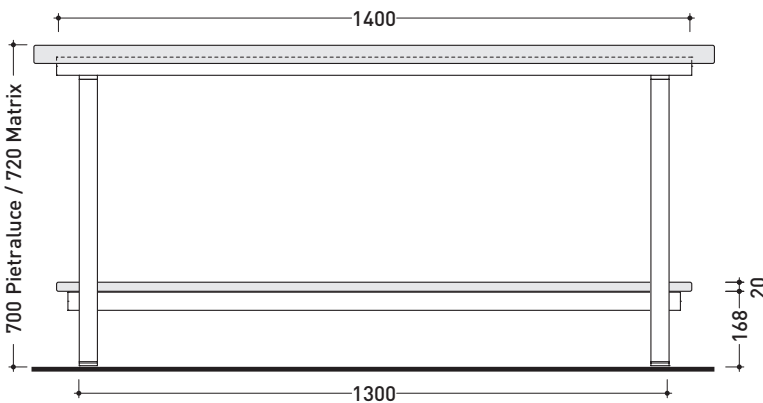

vista frontale / frontal view

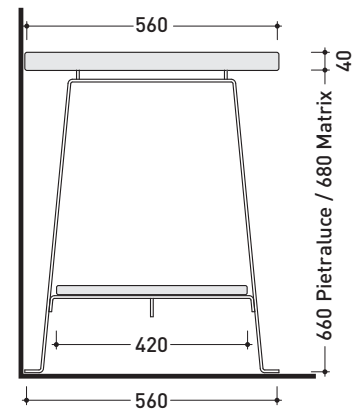

sezione longitudinale / section

sizes in mm

Please consider a 2% tolerance on indicated measurements

**PIETRALUCE:** glossy finish



**matt finish**

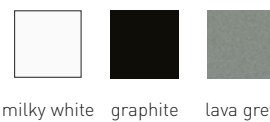

**MATRIX:** finishes

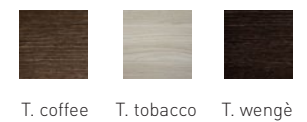

<http://www.ceramicaflaminia.it/en/products/298-make-up>

©ceramicaflaminiaspa - All rights reserved. Unauthorized copying, publication, reproduction as well as partial reproduction are prohibited

march 2017



# Make-up

➔ **FLAMINIA.**

design **PAOLA NAVONE**

2011

## MKP180 Make-up 180

Bench 180 cm with satined steel structure and Matrix or Pietraluce top

Complements: **Make-Up mirrors** (MKS100 - MKS50 - MKS501)

Package dim. Pietraluce 177 x 60 x 7 cm | Weight 80 kg | Pz. Pallet n° -

Package dim. Matrix 192 x 64 x 15 cm | Weight 70 kg | Pz. Pallet n° -



Basin or tap holes are not made on this article by Flaminia

CE

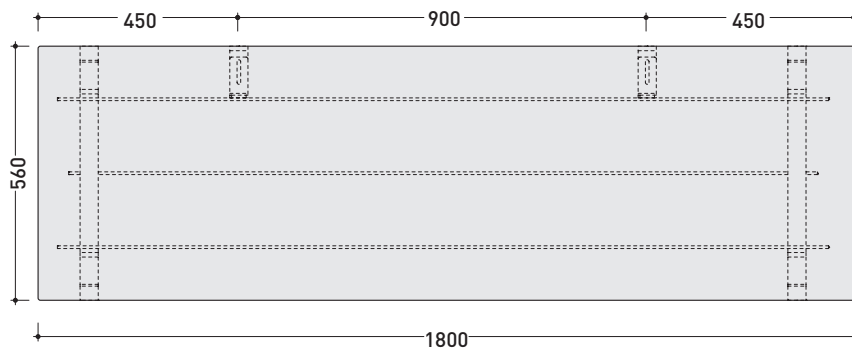

vista zenitale / zenital view

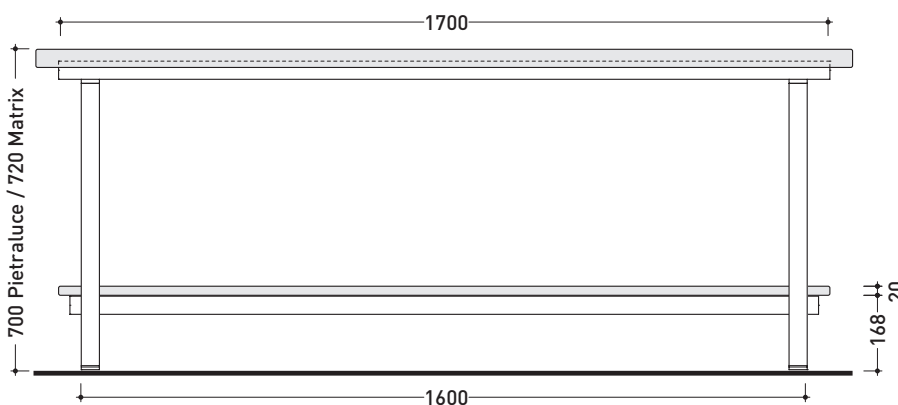

vista frontale / frontal view

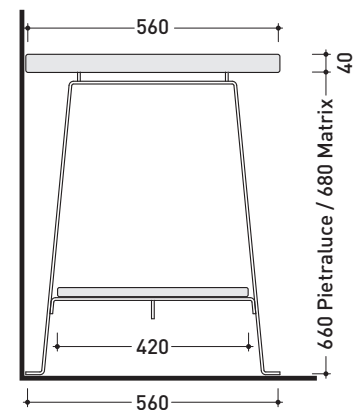

sezione longitudinale / section

sizes in mm

Please consider a 2% tolerance on indicated measurements

**PIETRALUCE:** glossy finish

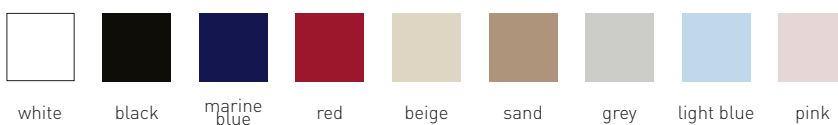

**matt finish**

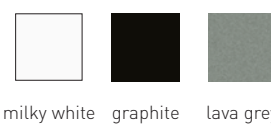

**MATRIX:** finishes

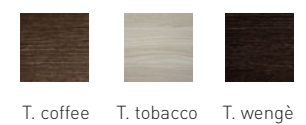

<http://www.ceramicaflaminia.it/en/products/298-make-up>

©ceramicaflaminiaspa - All rights reserved. Unauthorized copying, publication, reproduction as well as partial reproduction are prohibited

march 2017

