

FY40PC + MW40SP

Varnished extra_light crystal top from 80 to 200 cm
suitable for Miniwash 40 under-counter basin (fixing brackets included)

Complements: Miniwash 40 under-counter basin (MW40SP)
MAKE-UP mirrors and lamps
APP - FLAG - MADRE - SIMPLE mirrors
Hot/Cold mirror (SPHC)
Left/Right mirror (SPLR)
Line mirrors (BASC20 - BASC30 - BASC40)
Taps basin line: ONE - NOKÈ - FOLD - SI - X1
Accessories line: TWO - HOOP - NOKÈ - FOLD



Package dim.

Weight

Pz. Pallet n° -

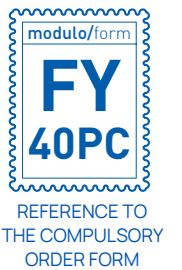
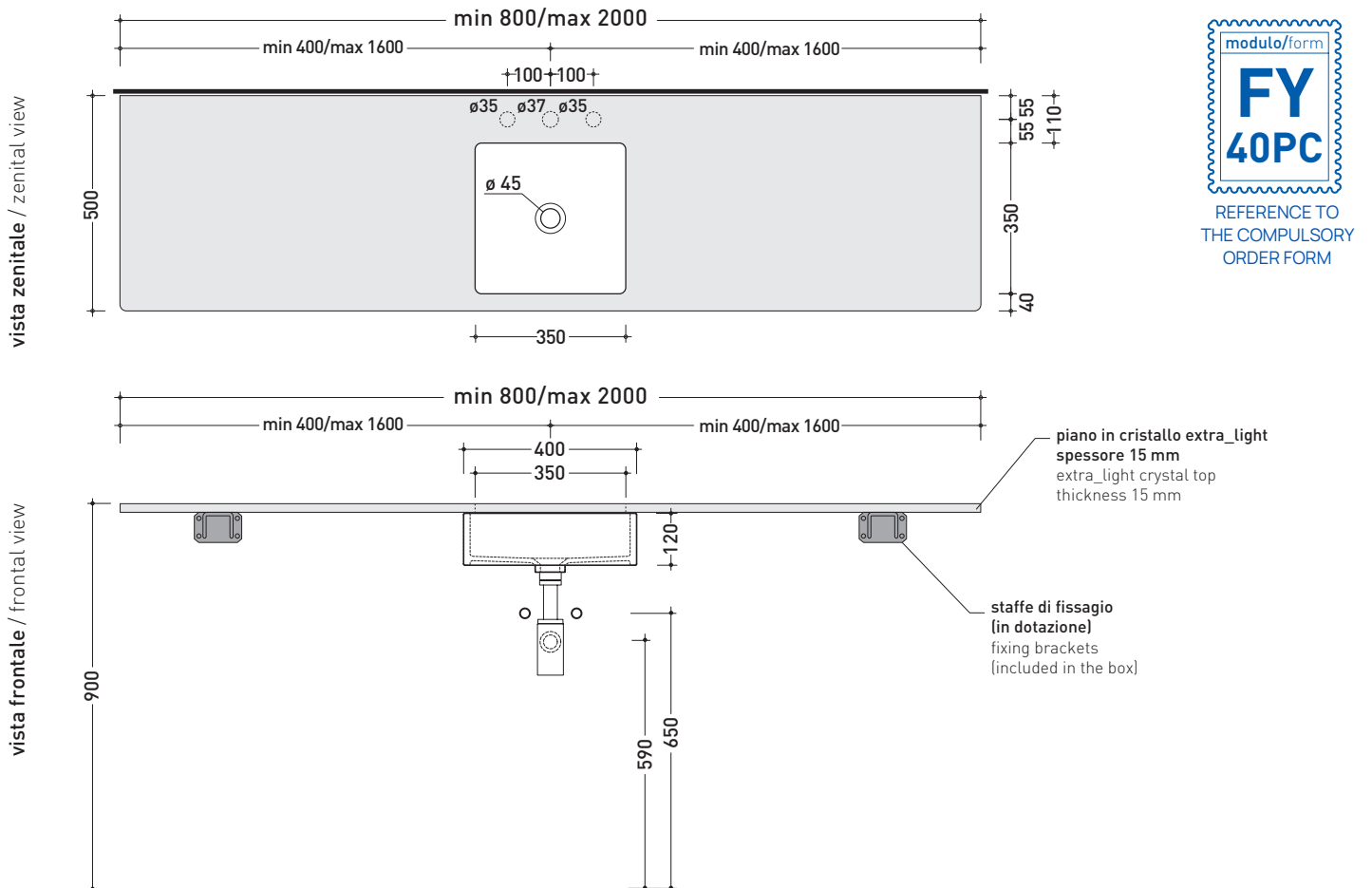

sizes in mm

Please consider a 2% tolerance on indicated measurements

CRYSTAL: glossy finish



white



black

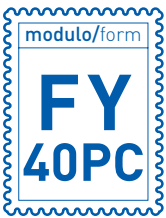

MODULO PER LA REALIZZAZIONE DEI PIANI IN CRISTALLO **FLY** A MISURA PER ART. **MW40SP**
FLY CUSTOMIZED CRYSTAL SHELVES FOR ART. MW40SP FORM

E' obbligatorio fotocopiare questa pagina, compilarla con cura e allegarla all'ordine.
 Is compulsory to photocopy this page, carefully fill in and attach to the order.

» **1** DETTAGLI ORDINE / ORDER DETAILS

ordinante - buyer cliente - client

ordine - order n: data - date: ref.:

annotazioni - notes

» **2** SCELTA ARTICOLO / ITEM CHOICE

E' importante consultare prima la scheda tecnica relativa
 It's important to consult before the technical detail

art. **FY40PC**
 mensola / shelf da / from **80 a / to 200 cm**

» **3** SCELTA COLORE / COLOUR SELECTION

CRISTALLO EXTRA_LIGHT
 EXTRA_LIGHT CRYSTAL

bianco - white nero - black

» **4** SCELTA DETTAGLI / DETAILS SELECTION

FORI RUBINETTERIA / TAP HOLES

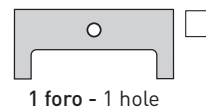
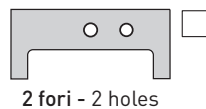
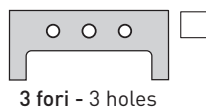

» **5** SCELTA MISURE / MEASURES

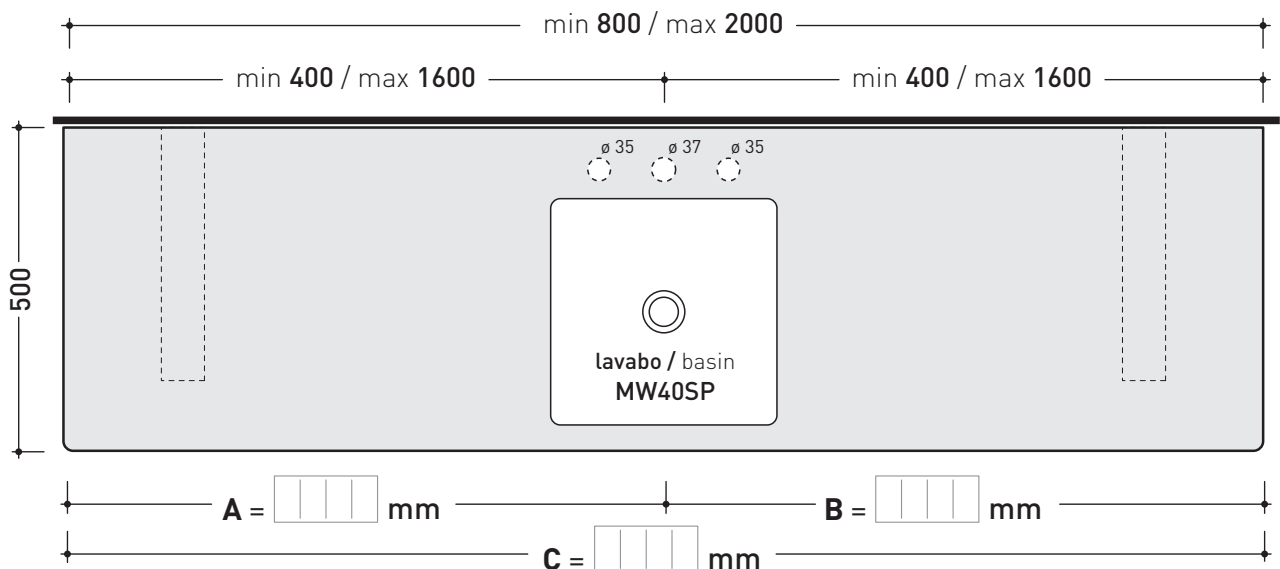

- **A** = misura interasse lavabo da sinistra / left distance of basin.
- **B** = misura interasse lavabo da destra / right distance of basin.
- **C** = misura totale del piano / total length of the shelf.
- verificare sempre che / verify that: **A + B = C.**

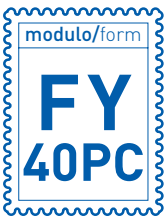

MODULO PER LA REALIZZAZIONE DEI PIANI IN CRISTALLO **FLY** A MISURA PER DOPPIO ART. **MW40SP**
FLY CUSTOMIZED CRYSTAL SHELVES FOR DOUBLE ART. MW40SP FORM



E' obbligatorio fotocopiare questa pagina, compilarla con cura e allegarla all'ordine.
 Is compulsory to photocopy this page, carefully fill in and attach to the order.

➔➔ **1** **DETTAGLI ORDINE / ORDER DETAILS**

ordinante - buyer _____ cliente - client _____

ordine - order n: _____ data - date: _____ ref.: _____

annotazioni - notes _____

➔➔ **2** **SCelta ARTICOLO / ITEM CHOICE**

E' importante consultare prima la scheda tecnica relativa
 It's important to consult before the technical detail

art. **FY40PC**
 mensola / shelf da / from **140 a / to 200 cm**

➔➔ **3** **SCelta COLORE / COLOUR SELECTION**

CRISTALLO EXTRA_LIGHT
EXTRA_LIGHT CRYSTAL

bianco - white nero - black

➔➔ **4** **SCelta DETTAGLI / DETAILS SELECTION**

FORI RUBINETTERIA / TAP HOLES

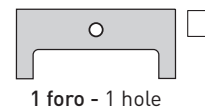
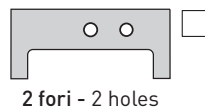
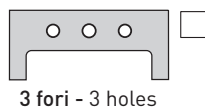

➔➔ **5** **SCelta MISURE / MEASURES**

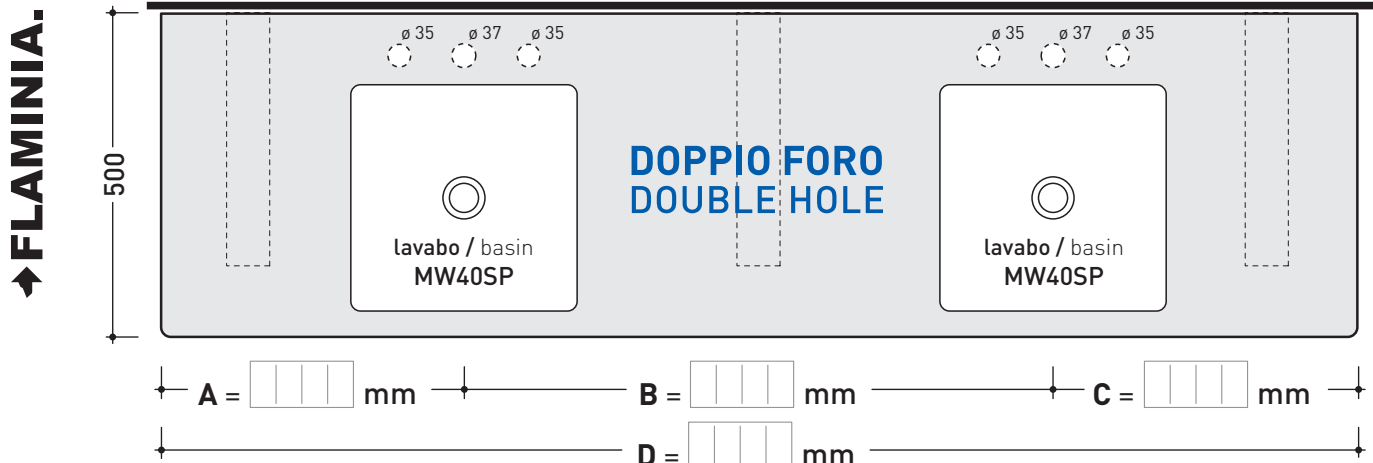
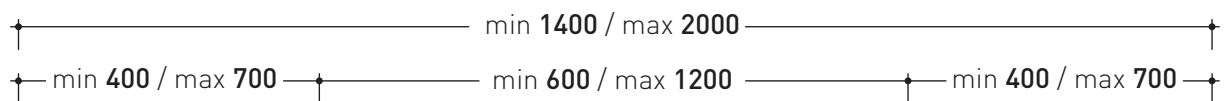

- **A** = misura interasse lavabo da sinistra / left distance of basin.
- **B** = misura interasse lavabo da destra / right distance of basin.
- **C** = misura totale del piano / total length of the shelf.
- verificare sempre che / verify that: **A + B + C = D.**