

2017

BX990 L 70 x P 37 x H 25

Base portlavabo sospesa H25 - 1 CASSETTO

TOP ESCLUSO

Complementi: **lavabi appoggio:**
Boll 42 (BL42L) / **Boll 56** (BL56L) / **Monò 54** (MN54L) /
NudaSlim 60 (ND60A / ND60L / ND60PR) / **NudaSlim 75** (ND75A /
 ND75L / ND75PR) / **Pass 39** (PS39LM) / **Pass 60** (PS60A) / **Pass 62**
 (PS62C) / **Pass 65** (PS65AT) / **Saltodacqua** (SD42L) / **Void 44** (VD44L)
Specchi linea SIMPLE, MAKE-UP, APP

Accessori tecnici: **Sifone salvaspazio**

Dim. Imballo | Peso **12,6 kg** | Pz. Pallet n° -

CE

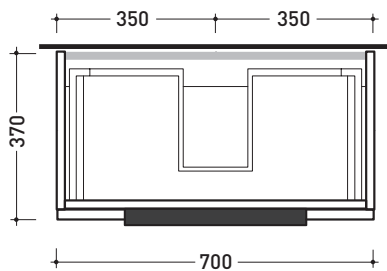

vista zenitale / zenital view

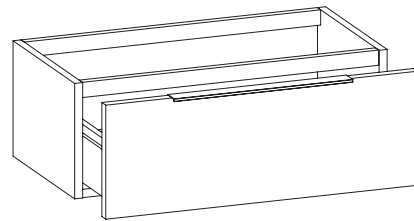

assonometria / axonometry

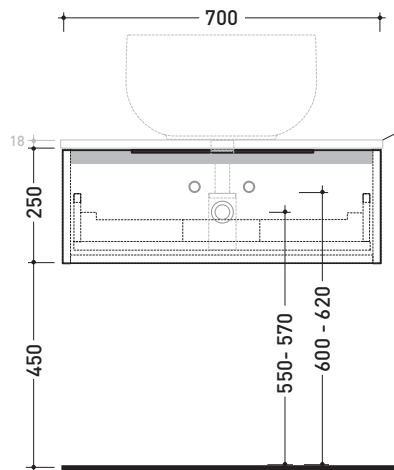

vista frontale / frontal view

TOP ESCLUSO
TOP NOT INCLUDED

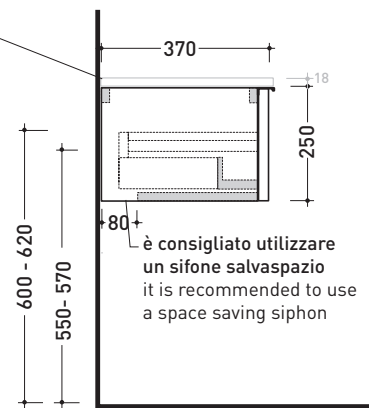

sezione longitudinale / section

dimensioni in mm

LEGGNO: finiture



OK Arly



OJ Bianco



OJ Grigio



OJ Canapa

2017

BX992 L 85 x P 37 x H 25

Base portlavabo sospesa H25 - 1 CASSETTO

TOP ESCLUSO

Complementi: lavabi appoggio:
Boll 42 (BL42L) / **Boll 56** (BL56L) / **Monò 54** (MN54L) /
NudaSlim 60 (ND60A / ND60L / ND60PR) / **NudaSlim 75** (ND75A /
 ND75L / ND75PR) / **Pass 39** (PS39LM) / **Pass 60** (PS60A) / **Pass 62**
 (PS62C) / **Pass 65** (PS65AT) / **Saltodacqua** (SD42L) / **Void 44** (VD44L)
 Specchi linea SIMPLE, MAKE-UP, APP

Accessori tecnici: **Sifone salvaspazio**

Dim. Imballo | Peso **13,8 kg** | Pz. Pallet n° -

CE

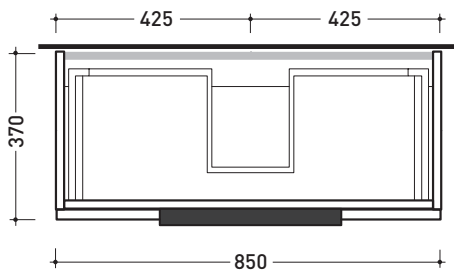

vista zenitale / zenital view

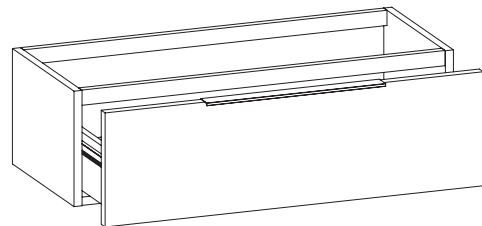

assonometria / axonometry

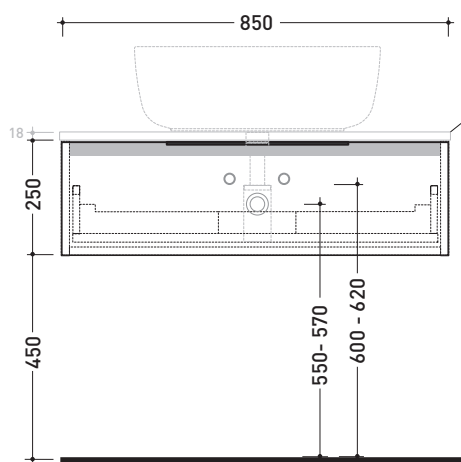

vista frontale / frontal view

TOP ESCLUSO
TOP NOT INCLUDED

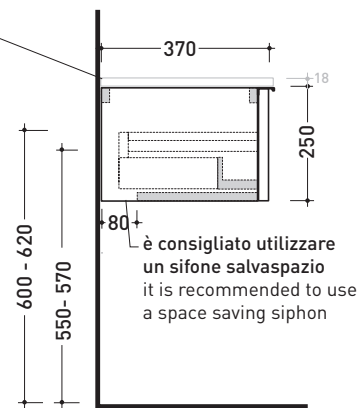

sezione longitudinale / section

è consigliato utilizzare
un sifone salvaspazio
it is recommended to use
a space saving siphon

dimensioni in mm

LEGGNO: finiture



OK Arly



OJ Bianco



OJ Grigio



OJ Canapa

2017

BX994 L 95 x P 37 x H 25

Base portlavabo sospesa H25 - 1 CASSETTO
TOP ESCLUSO

Complementi: **lavabi appoggio:**
Boll 42 (BL42L) / **Boll 56** (BL56L) / **Monò 54** (MN54L) /
NudaSlim 60 (ND60A / ND60L / ND60PR) / **NudaSlim 75** (ND75A /
 ND75L / ND75PR) / **Pass 39** (PS39LM) / **Pass 60** (PS60A) / **Pass 62**
 (PS62C) / **Pass 65** (PS65AT) / **Saltodacqua** (SD42L) / **Void 44** (VD44L)
Specchi linea SIMPLE, MAKE-UP, APP

Accessori tecnici: **Sifone salvaspazio**

Dim. Imballo | Peso **15,1 kg** | Pz. Pallet n° -

CE

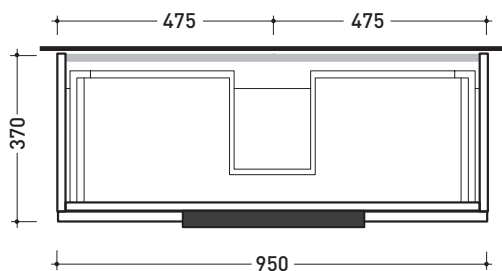

vista zenitale / zenital view

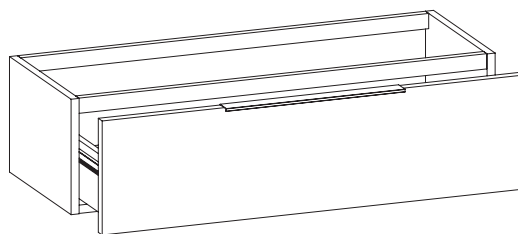

assonometria / axonometry

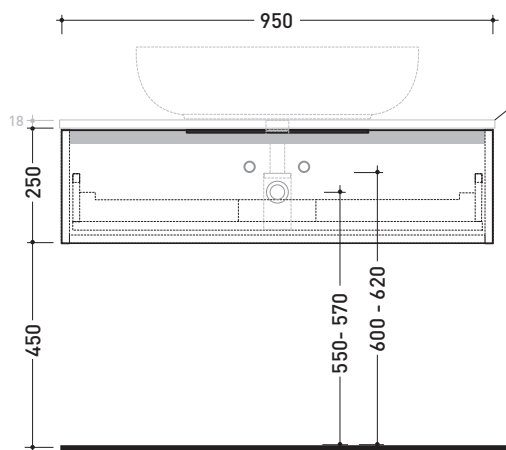

vista frontale / frontal view

TOP ESCLUSO
 TOP NOT INCLUDED

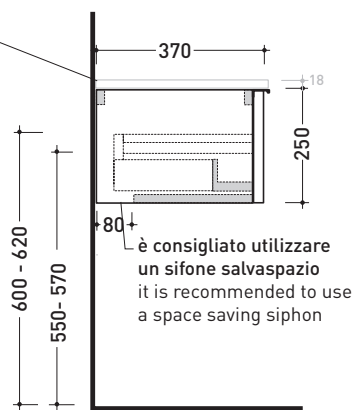

sezione longitudinale / section

è consigliato utilizzare
 un sifone salvaspazio
 it is recommended to use
 a space saving siphon

dimensioni in mm

LEGNO: finiture



OK Arly



OJ Bianco



OJ Grigio



OJ Canapa

2017

BX968 L 105 x P 37 x H 25

Base portlavabo sospesa H25 - 1 CASSETTO

TOP ESCLUSO

Complementi: **lavabi appoggio:**
Boll 42 (BL42L) / **Boll 56** (BL56L) / **Monò 54** (MN54L) /
NudaSlim 60 (ND60A / ND60L / ND60PR) / **NudaSlim 75** (ND75A /
 ND75L / ND75PR) / **Pass 39** (PS39LM) / **Pass 60** (PS60A) / **Pass 62**
 (PS62C) / **Pass 65** (PS65AT) / **Saltodacqua** (SD42L) / **Void 44** (VD44L)
Specchi linea SIMPLE, MAKE-UP, APP

Accessori tecnici: **Sifone salvaspazio**

Dim. Imballo | Peso **17,3 kg** | Pz. Pallet n° -

CE

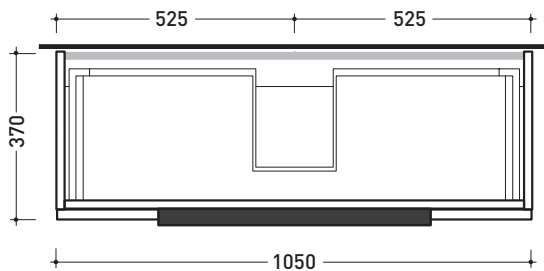

vista zenitale / zenital view

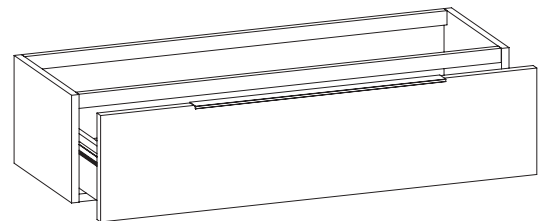

assonometria / axonometry

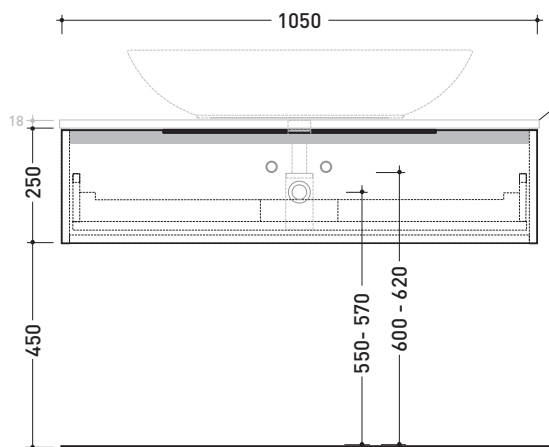

vista frontale / frontal view

TOP ESCLUSO
TOP NOT INCLUDED

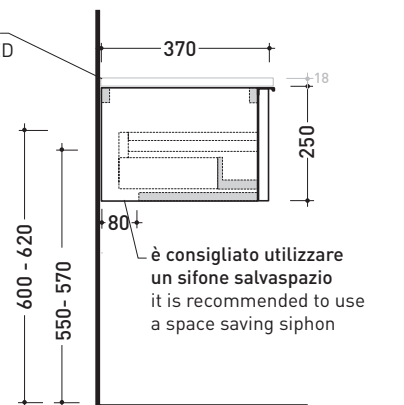

sezione longitudinale / section

dimensioni in mm

LEGNO: finiture



OK Arly



OJ Bianco



OJ Grigio



OJ Canapa

2017

BXPR38 L 70/245 x P 38 x H 18

Piano di copertura in legno da cm 70 a 245
per BASI PORTALAVABO e BASI SOSPESE prof. 37 cm

ATTENZIONE:

Flaminia può forare il piano per l'alloggiamento di lavabi d'appoggio solo in corrispondenza dell'asse centrale della **BASE PORTALAVABO** sottostante.

CE

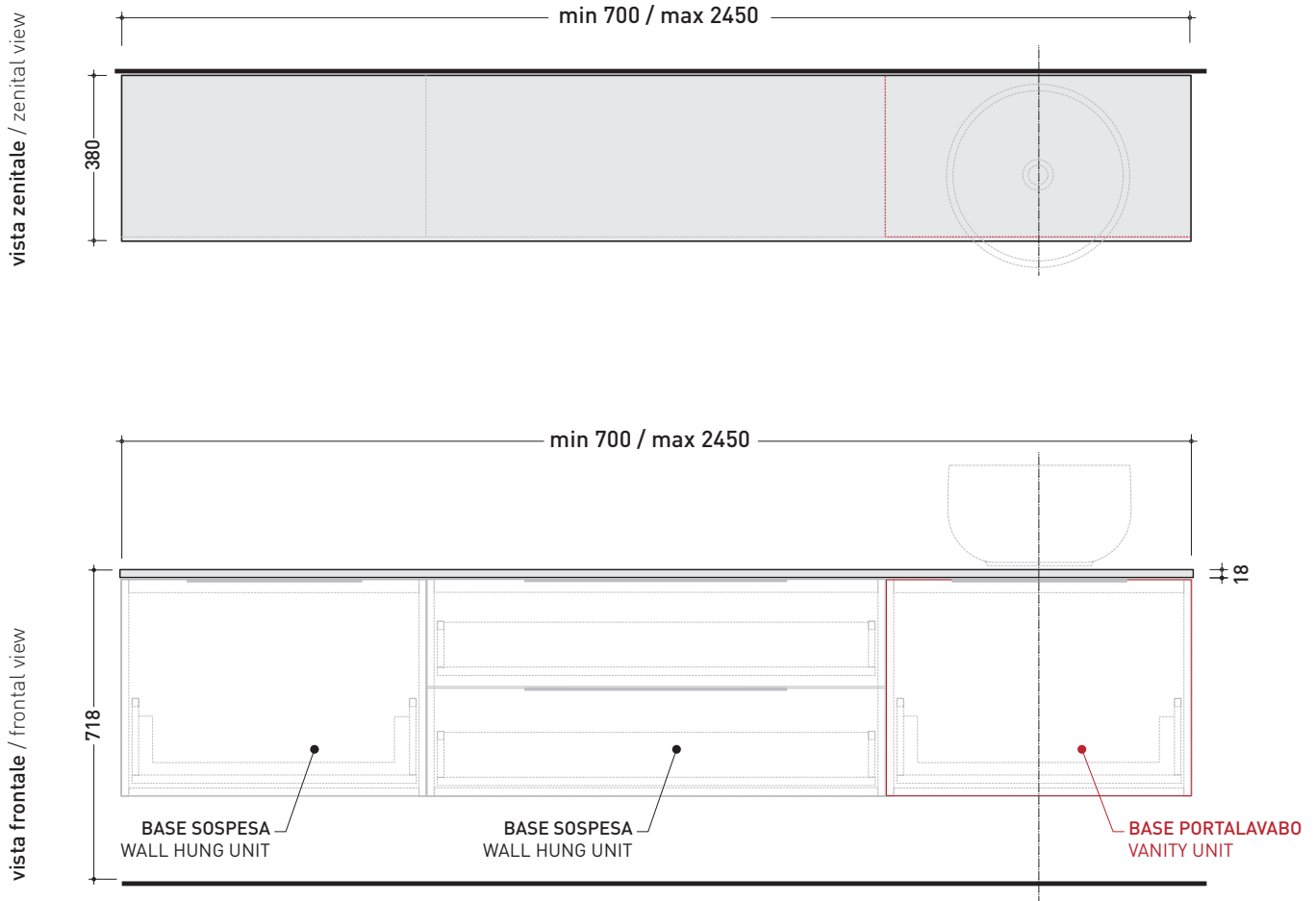

dimensioni in mm

LEGNO: finiture



OK Arly



OJ Bianco



OJ Grigio



OJ Canapa

LAVABI DA APPOGGIO COMPATIBILI

PROFONDITÀ BASE PORTALAVABO: **CM 37**

Boll 42 art. **BL42L**

Boll 56 art. **BL56L**

Monò 54 art. **MN54L**

NudaSlim 60 art. **ND60A**

NudaSlim 60 art. **ND60L**

NudaSlim 60 art. **ND60PR**

NudaSlim 75 art. **ND75A**

NudaSlim 75 art. **ND75L**

NudaSlim 75 art. **ND75PR**

Pass 39 art. **PS39LM**

Pass 60 art. **PS60A**

Pass 65 art. **PS65AT**

Pass 62 art. **PS62C**

Saltodacqua art. **SD42L**

Void 44 art. **VD44L**

INDICAZIONI PER LA REALIZZAZIONE DI COMPOSIZIONI

Fare attenzione alla differenza tra **BASI PORTALAVABO** e **BASI SOSPESE**:

- Le **BASI PORTALAVABO** hanno il cassetto predisposto per l'alloggiamento del sifone e la parte posteriore aperta per effettuare i collegamenti idraulici.
- Le **BASI SOSPESE** invece sono chiuse su ogni lato.

ATTENZIONE :

LA POSIZIONE DEL LAVABO È SEMPRE CENTRALE RISPETTO ALLA BASE PORTALAVABO

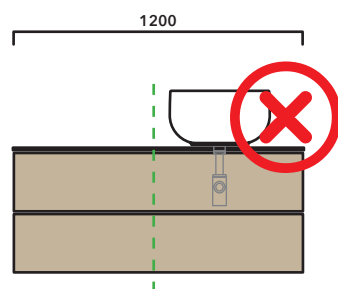
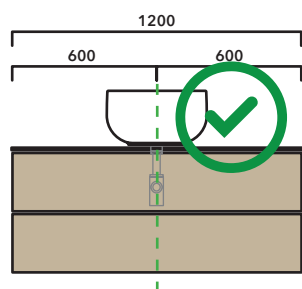

ATTENZIONE :

IL TOP NON È INCLUSO

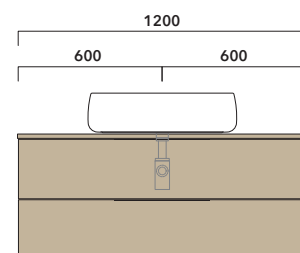
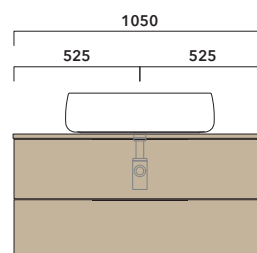
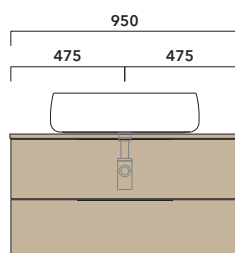
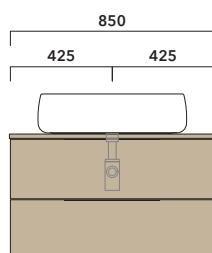
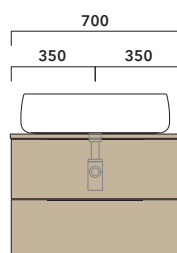

Le basi portalavabo sono utilizzabili solo con **LAVABI DA APPOGGIO** (NO incasso, semincasso, sottopiano).

ESEMPI DI COMPOSIZIONI

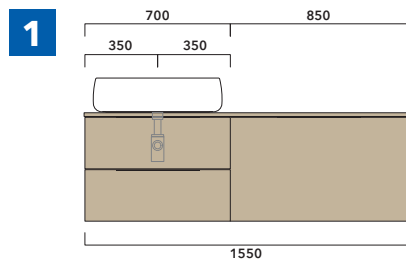

1 | profondità cm 37:
n.1 **BX808** + n.1 **BX426** + **BXPR38** cm 155

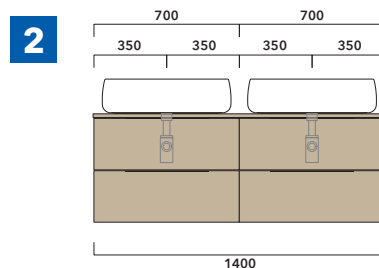

2 | profondità cm 37:
n.2 **BX808** + **BXPR38** cm 140

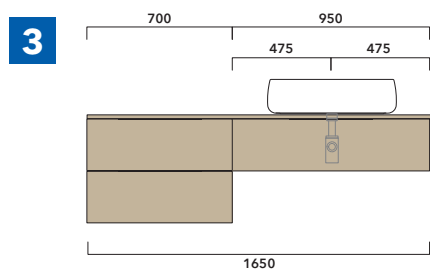

3 | profondità cm 37:
n.1 **BX424** + n. 1 **BX994** + **BXPR38** cm 165

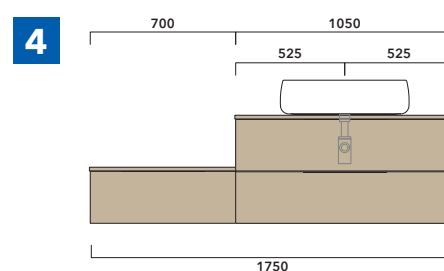

4 | profondità cm 37:
n.1 **BX296** + n. 1 **BX838** + **BXPR38** cm 70 +
BXPR38 cm 105

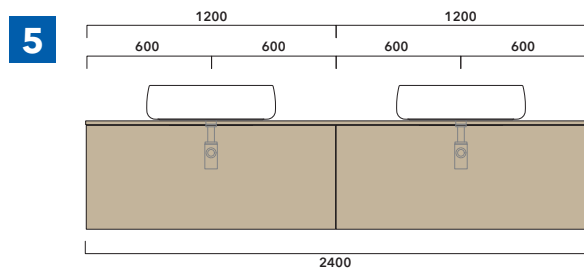

5 | profondità cm 37:
n.2 **BX944** + **BXPR38** cm 240

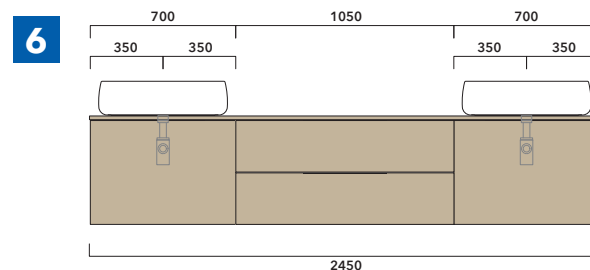

6 | profondità cm 37:
n.2 **BX804** + n.1 **BX436** + **BXPR38** cm 245

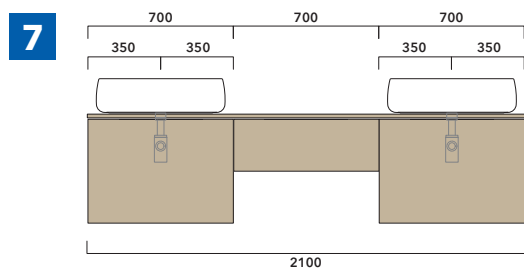

7 | profondità cm 37:
n.2 **BX804** + n. 1 **BX296** + **BXPR38** cm 210

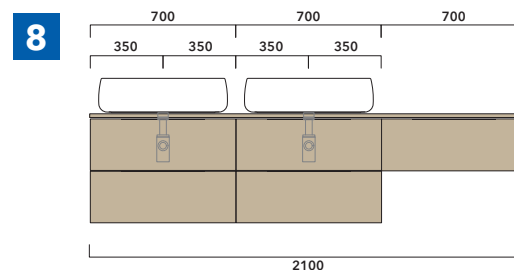

8 | profondità cm 37:
n.2 **BX808** + n. 1 **BX296** + **BXPR38** cm 210

➔ **FLAMINIA.** MODULO PER LA REALIZZAZIONE DELLE COMPOSIZIONI MOBILI **BOX**
CUSTOMIZED COMPOSITION FORM FOR **BOX** UNITS



E' obbligatorio fotocopiare questa pagina, compilarla con cura e allegarla all'ordine.
It is compulsory to photocopy this page, carefully fill in and attach to the order.

➔➔ **1** DETTAGLI ORDINE / ORDER DETAILS

ordinante - buyer _____ cliente - client _____

ordine - order n: _____ data - date: _____ ref.: _____

annotazioni - notes _____

➔➔ **2** PROFONDITÀ MOBILE / UNIT DEPTH É importante consultare il listino prezzi / It's important to consult price list

CM 37

CM 50

➔➔ **3** DISEGNO / DRAWING



➔➔ **4** ELENCO ARTICOLI / ARTICLE LIST É importante consultare il listino prezzi / It's important to consult price list

art. _____ dim. _____ art. _____ dim. _____

art. _____ dim. _____ art. _____ dim. _____

art. _____ dim. _____ art. _____ dim. _____

➔➔ **5** LAVABO DA APPOGGIO / COUTERTOP BASIN

FLAMINIA lavabo/basin art. _____

NO FLAMINIA lavabo/basin
(allegare scheda tecnica / enclose a technical drawing)

➔➔ **6** SCELTA FINITURA / FINISH SELECTION

OK ARLY

OJ BIANCO

OJ GRIGIO

OJ CANAPA