

2017

BX296 L 70 x P 37 x H 25

Base sospesa H25 - 1 CASSETTO

TOP ESCLUSO

Complementi: Specchi linea SIMPLE, MAKE-UP, APP

Dim. Imballo

Peso **14,4 kg**

Pz. Pallet n° -



CE

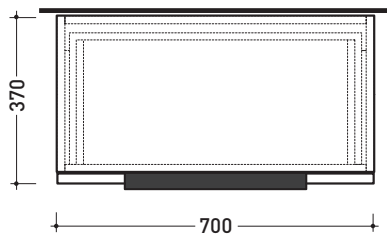

vista zenitale / zenital view

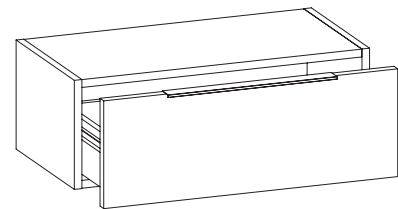

assonometria / axonometry

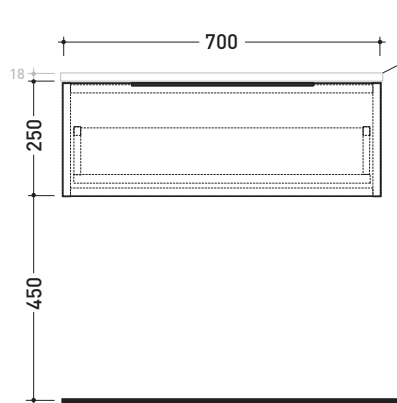

vista frontale / frontal view

TOP ESCLUSO
TOP NOT INCLUDED

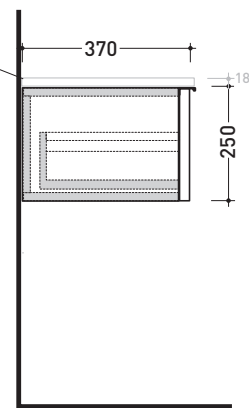

sezione longitudinale / section

dimensioni in mm

LEGNO: finiture



OK Arly



OJ Bianco



OJ Grigio



OJ Canapa

2017

BX288 L 85 x P 37 x H 25

Base sospesa H25 - 1 CASSETTO

TOP ESCLUSO

Complementi: Specchi linea SIMPLE, MAKE-UP, APP

Dim. Imballo

Peso **14,5 kg**

Pz. Pallet n° -



CE

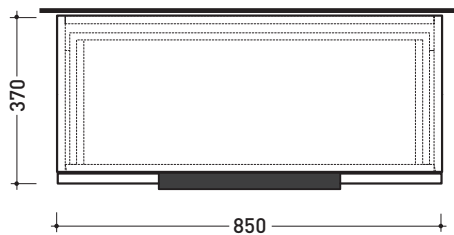

vista zenitale / zenital view

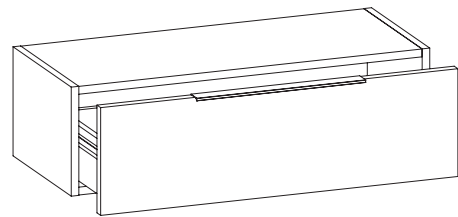

assonometria / axonometry

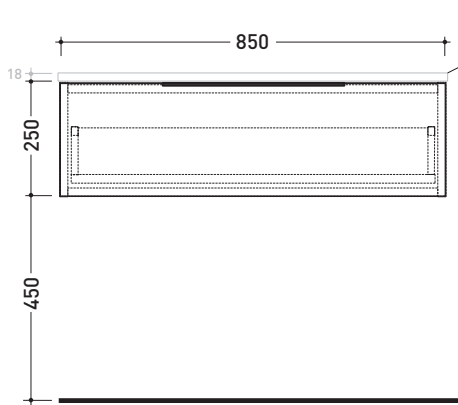

vista frontale / frontal view

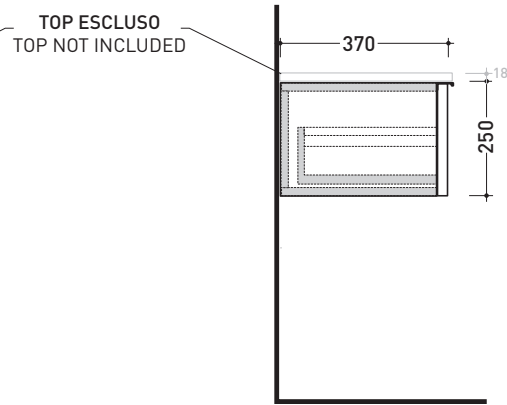

sezione longitudinale / section

dimensioni in mm

LEGNO: finiture



OK Arly



OJ Bianco



OJ Grigio



OJ Canapa

2017

BX298 L 95 x P 37 x H 25

Base sospesa H25 - 1 CASSETTO

TOP ESCLUSO

Complementi: Specchi linea SIMPLE, MAKE-UP, APP

Dim. Imballo

Peso **16,7 kg**

Pz. Pallet n° -



CE

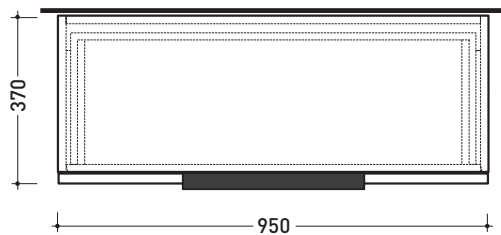

vista zenitale / zenital view

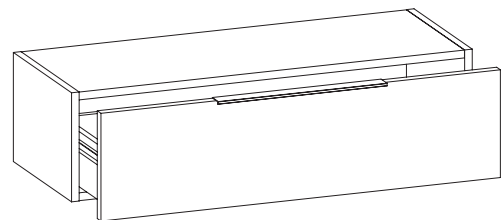

assonometria / axonometry

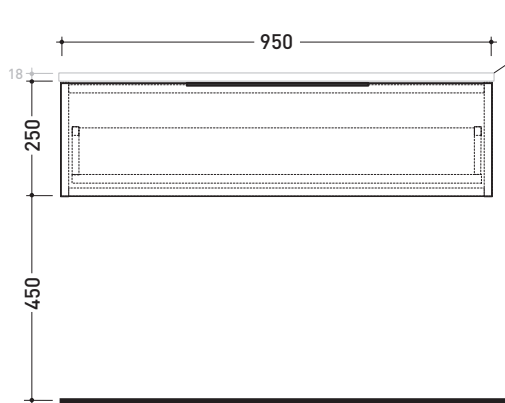

vista frontale / frontal view

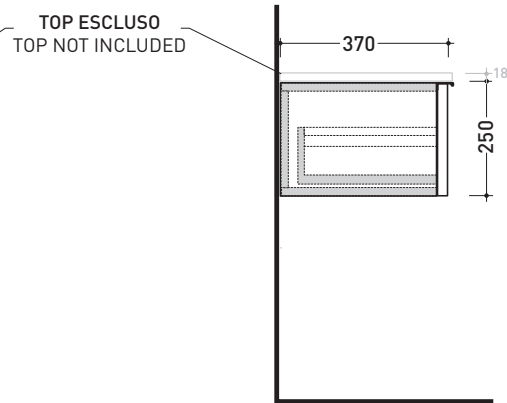

sezione longitudinale / section

dimensioni in mm

LEGNO: finiture



OK Arly



OJ Bianco



OJ Grigio



OJ Canapa

2017

BX286 L 105 x P 37 x H 25

Base sospesa H25 - 1 CASSETTO

TOP ESCLUSO

Complementi: Specchi linea SIMPLE, MAKE-UP, APP

Dim. Imballo

Peso **18,5 kg**

Pz. Pallet n° -



CE

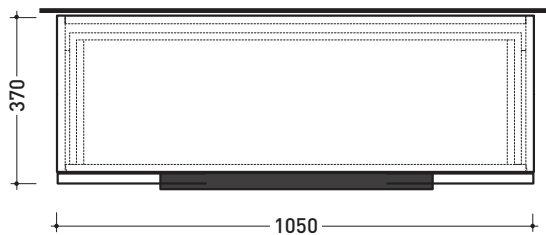

vista zenitale / zenital view

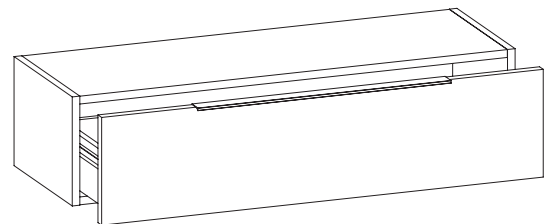

assonometria / axonometry

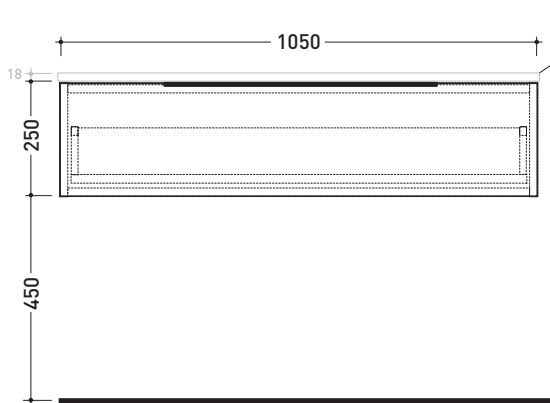

vista frontale / frontal view

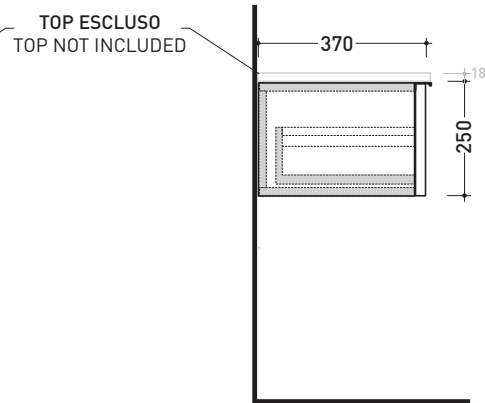

sezione longitudinale / section

dimensioni in mm

LEGNO: finiture



OK Arly



OJ Bianco



OJ Grigio



OJ Canapa

ESEMPI DI COMPOSIZIONI

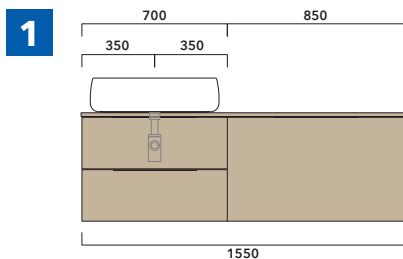

1 | profondità cm 37:
n.1 **BX808** + n.1 **BX426** + **BXPR38** cm 155

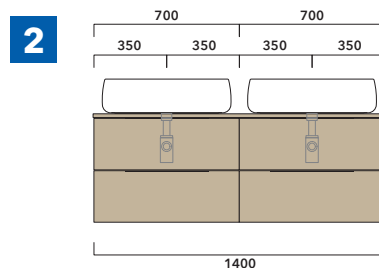

2 | profondità cm 37:
n.2 **BX808** + **BXPR38** cm 140

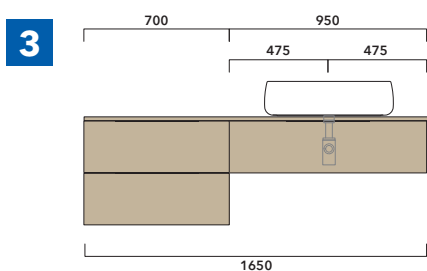

3 | profondità cm 37:
n.1 **BX424** + n. 1 **BX994** + **BXPR38** cm 165

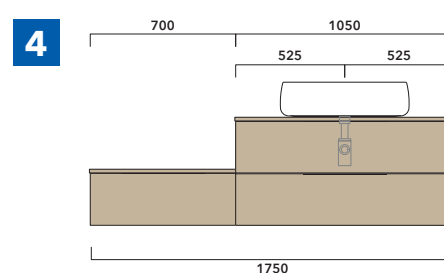

4 | profondità cm 37:
n.1 **BX296** + n. 1 **BX838** + **BXPR38** cm 70 +
BXPR38 cm 105

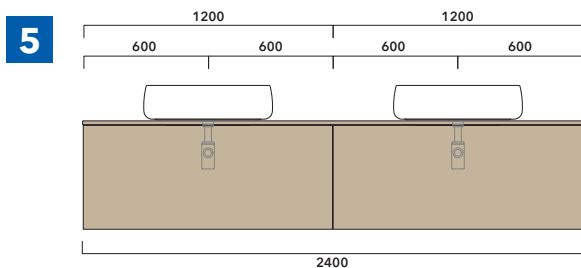

5 | profondità cm 37:
n.2 **BX944** + **BXPR38** cm 240

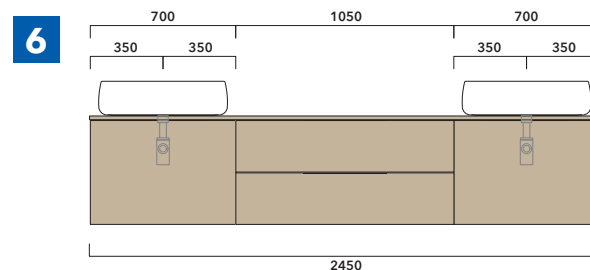

6 | profondità cm 37:
n.2 **BX804** + n.1 **BX436** + **BXPR38** cm 245

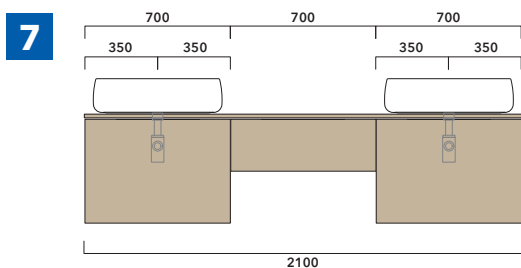

7 | profondità cm 37:
n.2 **BX804** + n. 1 **BX296** + **BXPR38** cm 210

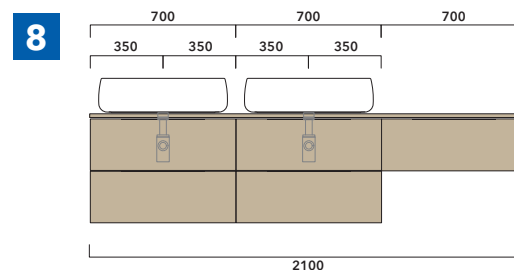

8 | profondità cm 37:
n.2 **BX808** + n. 1 **BX296** + **BXPR38** cm 210

