

2017

BX422 L 70 x P 37 x H 50

Wall hung unit H50 - 1 DRAWER

TOP NOT INCLUDED

Complements: **Mirrors line:** SIMPLE, MAKE-UP, APP

Package dim.

Weight **22,4 kg**

Pz. Pallet n° -



CE

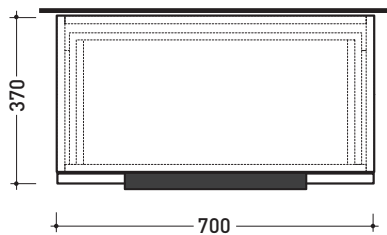

vista zenitale / zenital view

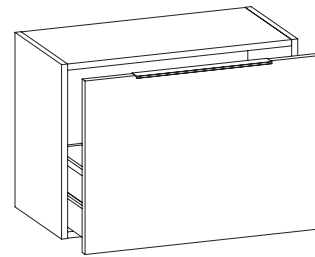

assonometria / axonometry

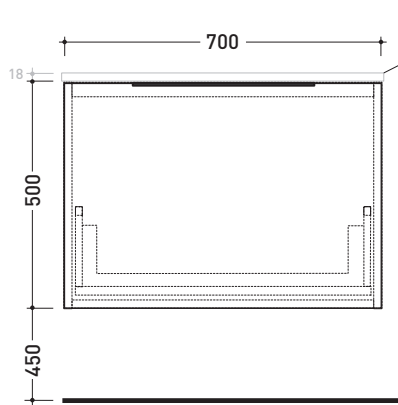

vista frontale / frontal view

TOP ESCLUSO
TOP NOT INCLUDED

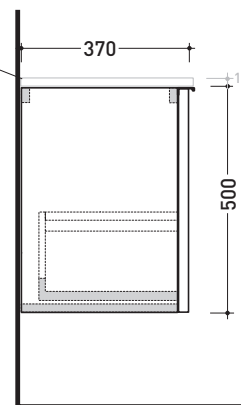

sezione longitudinale / section

sizes in mm

WOOD: finish



OK Arly



OJ Bianco



OJ Grigio



OJ Canapa

2017

BX426 L 85 x P 37 x H 50

Wall hung unit H50 - 1 DRAWER

TOP NOT INCLUDED

Complements: **Mirrors line:** SIMPLE, MAKE-UP, APP

Package dim. | Weight **23,7 kg** | Pz. Pallet n° -



CE

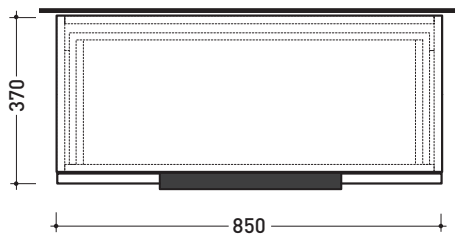

vista zenitale / zenital view

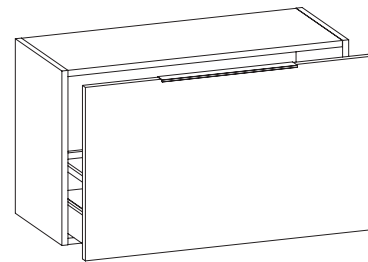

assonometria / axonometry

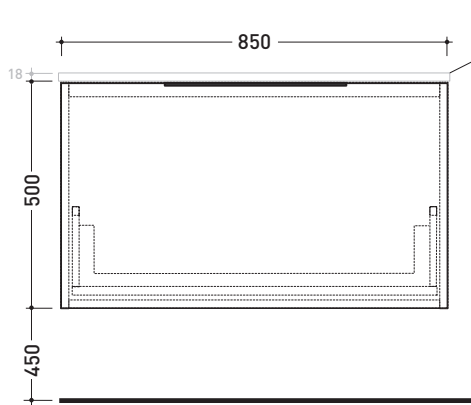

vista frontale / frontal view

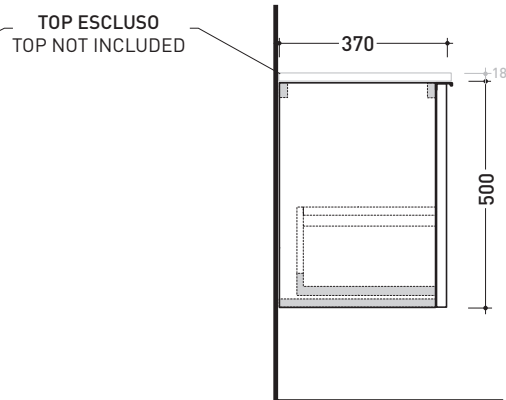

sezione longitudinale / section

sizes in mm

WOOD: finish



OK Arly



OJ Bianco



OJ Grigio



OJ Canapa

2017

BX430 L 95 x P 37 x H 50

Wall hung unit H50 - 1 DRAWER

TOP NOT INCLUDED

Complements: **Mirrors line:** SIMPLE, MAKE-UP, APP

Package dim. | Weight **24,3 kg** | Pz. Pallet n° -



CE

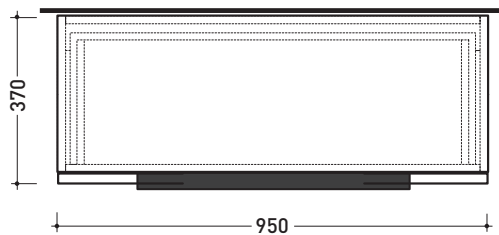

vista zenitale / zenital view

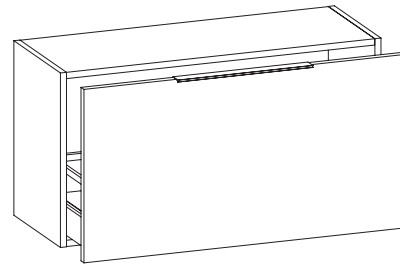

assonometria / axonometry

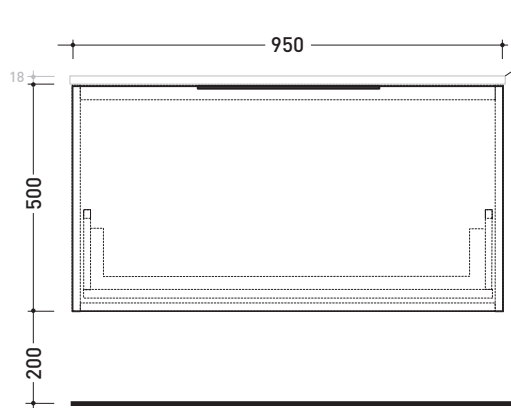

vista frontale / frontal view

TOP ESCLUSO
TOP NOT INCLUDED

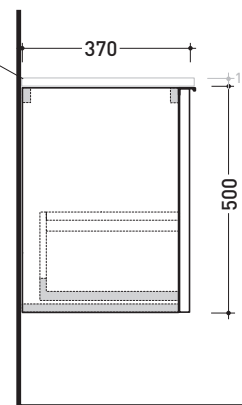

sezione longitudinale / section

sizes in mm

WOOD: finish



OK Arly



OJ Bianco



OJ Grigio



OJ Canapa

2017

BX434 L 105 x P 37 x H 50

Wall hung unit H50 - 1 DRAWER

TOP NOT INCLUDED

Complements: **Mirrors line:** SIMPLE, MAKE-UP, APP

Package dim. | Weight **22,4 kg** | Pz. Pallet n° -



CE

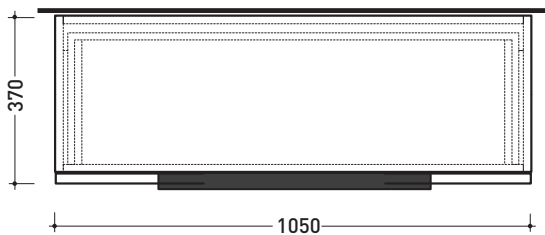

vista zenitale / zenital view

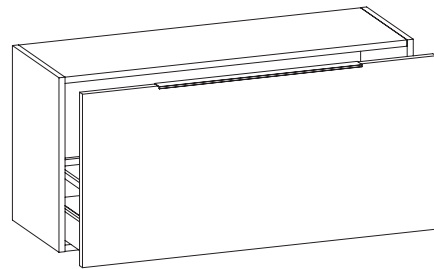

assonometria / axonometry

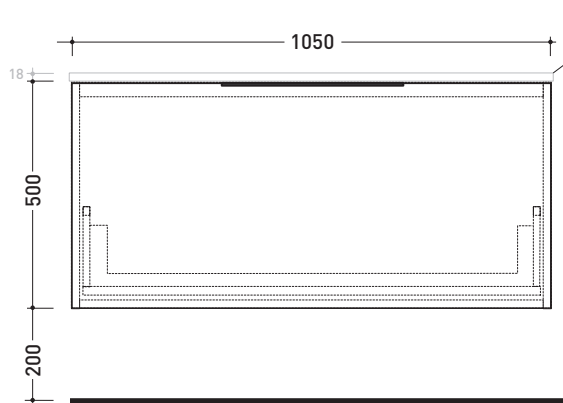

vista frontale / frontal view

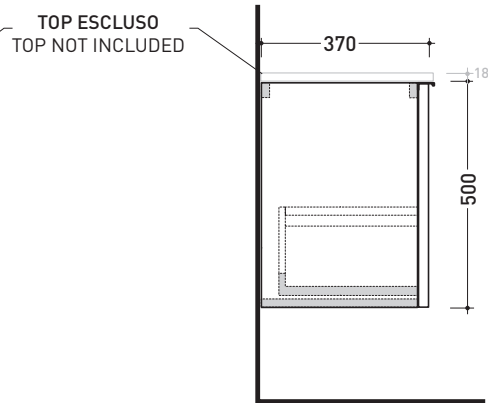

sezione longitudinale / section

sizes in mm

WOOD: finish



OK Arly



OJ Bianco



OJ Grigio



OJ Canapa

EXAMPLES OF COMPOSITIONS

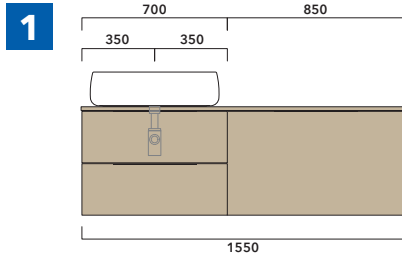

1 | depth cm 37:
n.1 **BX808** + n.1 **BX426** + **BXPR38** cm 155

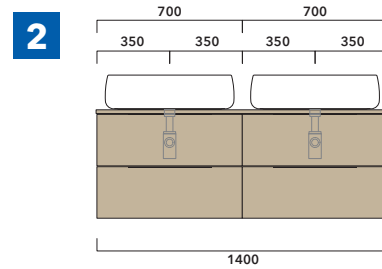

2 | depth cm 37:
n.2 **BX808** + **BXPR38** cm 140

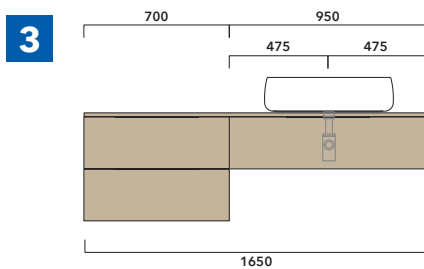

3 | depth cm 37:
n.1 **BX424** + n. 1 **BX994** + **BXPR38** cm 165

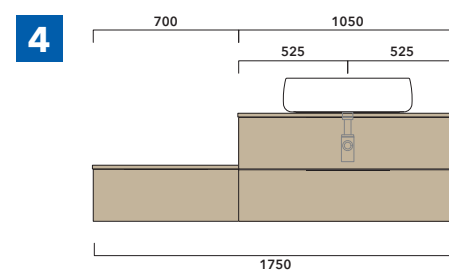

4 | depth cm 37:
n.1 **BX296** + n. 1 **BX838** + **BXPR38** cm 70 +
BXPR38 cm 105

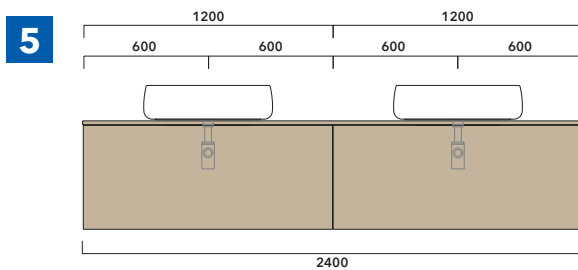

5 | depth cm 37:
n.2 **BX944** + **BXPR38** cm 240

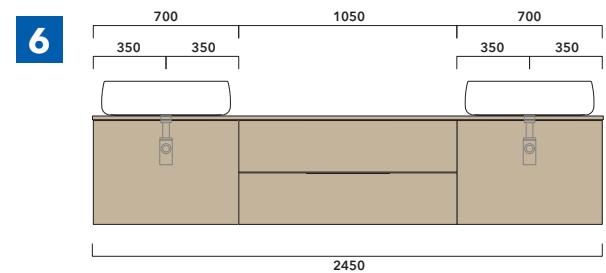

6 | depth cm 37:
n.2 **BX804** + n.1 **BX436** + **BXPR38** cm 245

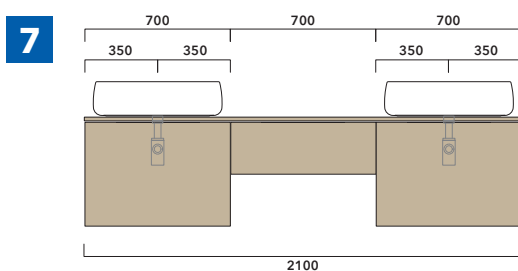

7 | depth cm 37:
n.2 **BX804** + n. 1 **BX296** + **BXPR38** cm 210

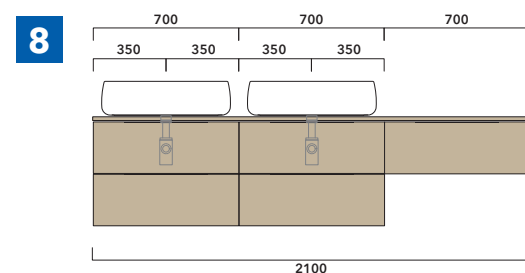

8 | depth cm 37:
n.2 **BX808** + n. 1 **BX296** + **BXPR38** cm 210

➔ **FLAMINIA.** MODULO PER LA REALIZZAZIONE DELLE COMPOSIZIONI MOBILI **BOX**
CUSTOMIZED COMPOSITION FORM FOR **BOX** UNITS



E' **obbligatorio** fotocopiare questa pagina, compilarla con cura e allegarla all'ordine.
It is compulsory to photocopy this page, carefully fill in and attach to the order.



DETTAGLI ORDINE / ORDER DETAILS

ordinante - buyer

cliente - client

ordine - order n:

data - date:

ref.:

annotazioni - notes



PROFONDITÀ MOBILE / UNIT DEPTH

É importante consultare il listino prezzi / It's important to consult price list

CM 37

CM 50



DISEGNO / DRAWING



ELENCO ARTICOLI / ARTICLE LIST

É importante consultare il listino prezzi / It's important to consult price list

art.

dim.

art.

dim.

art.

dim.

art.

dim.

art.

dim.

art.

dim.



LAVABO DA APPOGGIO / COUTERTOP BASIN

FLAMINIA lavabo/basin art. _____

NO FLAMINIA lavabo/basin
(allegare scheda tecnica / enclose a technical drawing)



SCELTA FINITURA / FINISH SELECTION

OK ARLY

OJ BIANCO

OJ GRIGIO

OJ CANAPA