

design ROMANO ADOLINI

2006

## UNA75L Una 75

Semi-inset basin 75 cm

•WITH OVERFLOW •ARRANGED FOR THREE HOLES TAP

Complements: **Una furnishing** (UNA75C1 - UNA75C2 - UNA75V1 - UNA75V2 - UNA75M1 - UNA75M2)

**Line taps basin:** ONE - NOKÉ - FOLD - SI

**Line accessories:** TWO - HOOP - NOKÉ - FOLD

Technical accessories: **Chrome siphon** (SIFL/CR) - **Telescopic chrome siphon** (SIFL066)

**Stop & Go drain** (PLSG)

**CERAMIC Stop & Go drain** (PLCE)

**Two piece set chrome tap filters** (RF026)

Package dim. **76 x 20,5 x 61 cm** | Weight **30,7 kg** | Pz. Pallet n° **10**



CE UNI EN 14688 - CL20 Dop-No14688

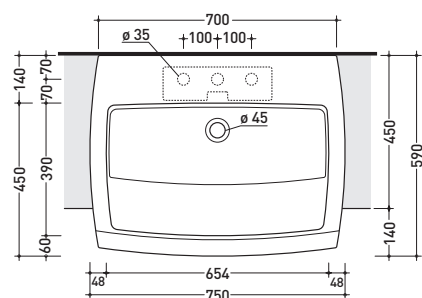

vista zenitale / zenital view

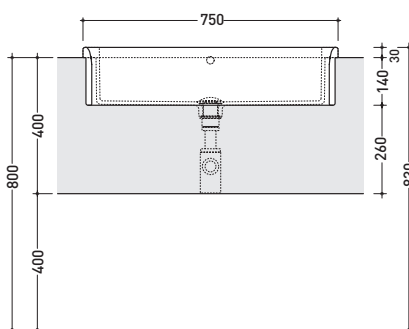

vista frontale / frontal view

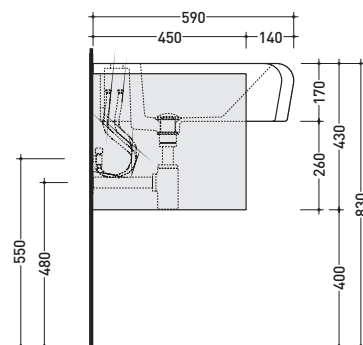

vista laterale / lateral view

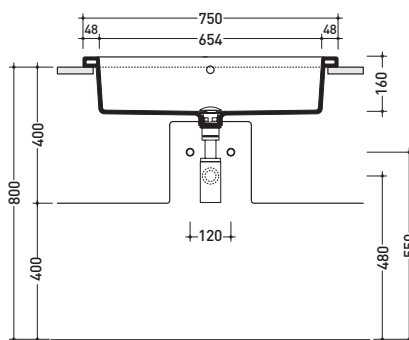

sezione trasversale / section

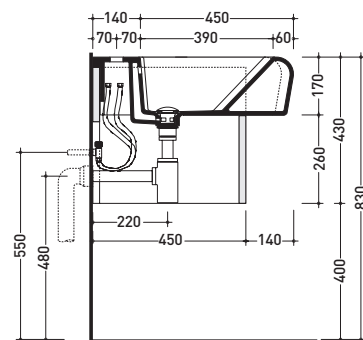

sezione longitudinale / section

sizes in mm

Please consider a 2% tolerance on indicated measurements

CERAMIC: glossy finish

matt finish



white



black



milky white