

FY40PC + MW40SP Fly

Piano in cristallo extra_light verniciato da cm 80 a 200 per lavabo Miniwash 40 sottopiano (staffe di fissaggio incluse)

Complementi: Lavabo Miniwash 40 (MW40SP)
 Specchi e Lampade MAKE-UP
 Specchi APP - FLAG - MADRE - SIMPLE
 Specchio Hot/Cold (SPHC)
 Specchio Left/Right (SPLR)
 Specchi Line (BASC20 - BASC30 - BASC40)

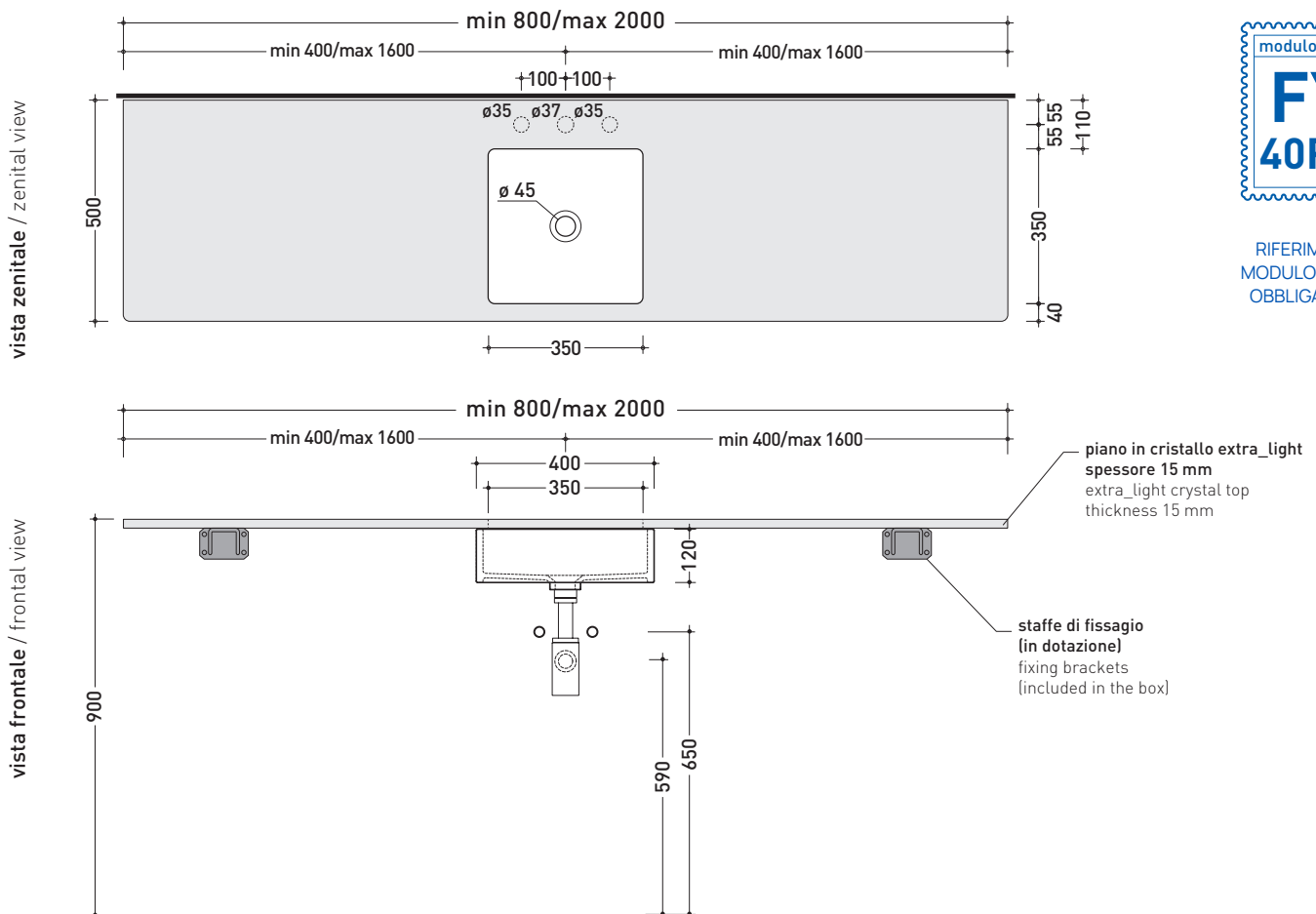

dimensioni in mm

CRISTALLO: finiture lucide



bianco

nero

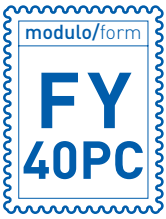

MODULO PER LA REALIZZAZIONE DEI PIANI IN CRISTALLO **FLY** A MISURA PER ART. **MW40SP**
FLY CUSTOMIZED CRYSTAL SHELVES FOR ART. MW40SP FORM

 **E' obbligatorio fotocopiare questa pagina, compilarla con cura e allegarla all'ordine.**
 Is compulsory to photocopy this page, carefully fill in and attach to the order.

➔➔ **1** DETTAGLI ORDINE / ORDER DETAILS

ordinante - buyer _____ cliente - client _____

ordine - order n: _____ data - date: _____ ref.: _____

annotazioni - notes _____

➔➔ **2** SCELTA ARTICOLO / ITEM CHOICE

E' importante consultare prima la scheda tecnica relativa
 It's important to consult before the technical detail

art. **FY40PC**
 mensola / shelf da / from **80 a / to 200 cm**

➔➔ **3** SCELTA COLORE / COLOUR SELECTION

CRISTALLO EXTRA_LIGHT
 EXTRA_LIGHT CRYSTAL

bianco - white nero - black

➔➔ **4** SCELTA DETTAGLI / DETAILS SELECTION

FORI RUBINETTERIA / TAP HOLES

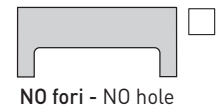
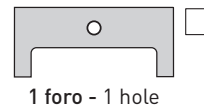
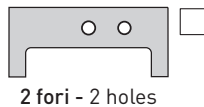
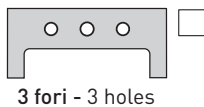

➔➔ **5** SCELTA MISURE / MEASURES

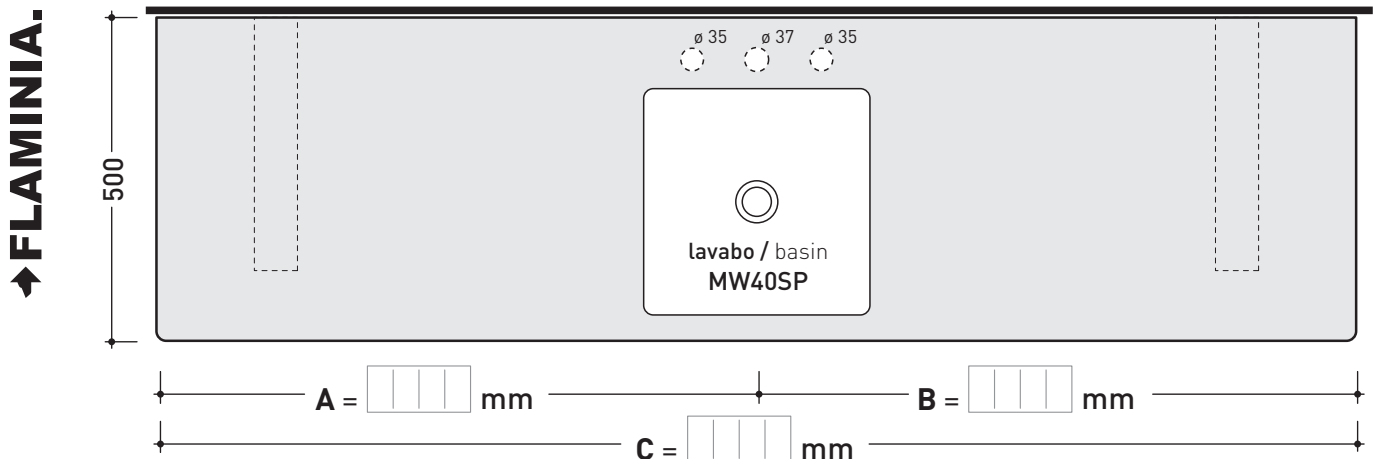

- **A** = misura interasse lavabo da sinistra / left distance of basin.
- **B** = misura interasse lavabo da destra / right distance of basin.
- **C** = misura totale del piano / total length of the shelf.
- verificare sempre che / verify that: **A + B = C**.

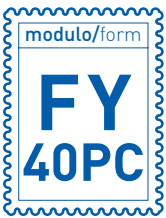

MODULO PER LA REALIZZAZIONE DEI PIANI IN CRISTALLO **FLY** A MISURA PER DOPPIO ART. **MW40SP**
FLY CUSTOMIZED CRYSTAL SHELVES FOR DOUBLE ART. MW40SP FORM



E' obbligatorio fotocopiare questa pagina, compilarla con cura e allegarla all'ordine.
 Is compulsory to photocopy this page, carefully fill in and attach to the order.

➔➔ **1** DETTAGLI ORDINE / ORDER DETAILS

ordinante - buyer _____ cliente - client _____

ordine - order n: _____ data - date: _____ ref.: _____

annotazioni - notes _____

➔➔ **2** SCELTA ARTICOLO / ITEM CHOICE

E' importante consultare prima la scheda tecnica relativa
 It's important to consult before the technical detail

art. **FY40PC**
 mensola / shelf da / from **140 a / to 200 cm**

➔➔ **3** SCELTA COLORE / COLOUR SELECTION

CRISTALLO EXTRA_LIGHT
 EXTRA_LIGHT CRYSTAL

bianco - white nero - black

➔➔ **4** SCELTA DETTAGLI / DETAILS SELECTION

FORI RUBINETTERIA / TAP HOLES

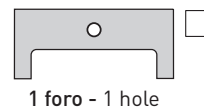
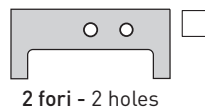
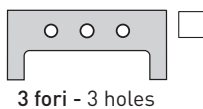

➔➔ **5** SCELTA MISURE / MEASURES

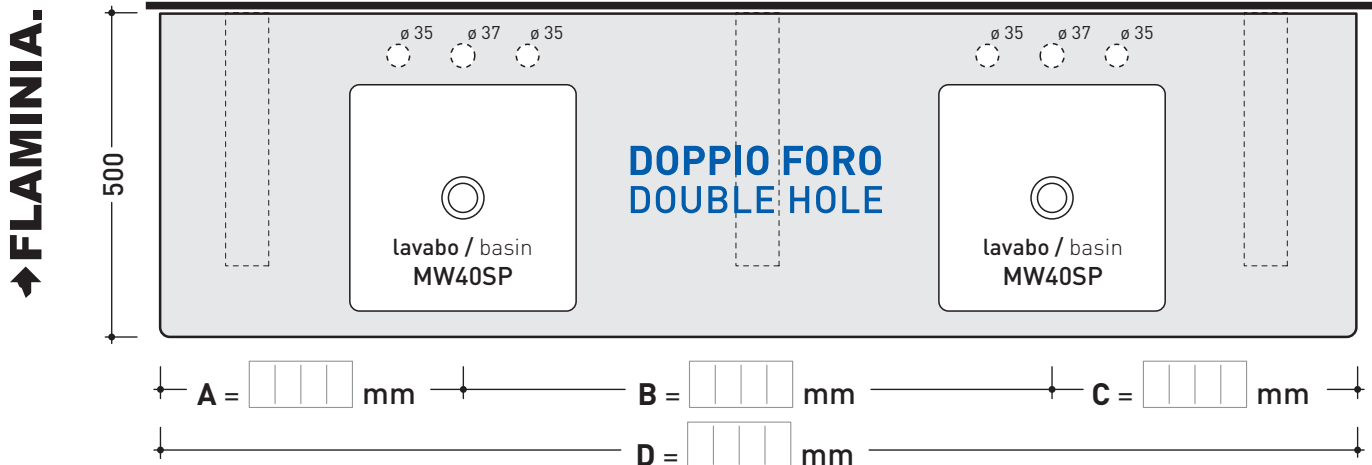
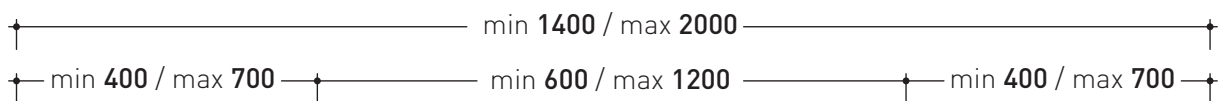

- **A** = misura interasse lavabo da sinistra / left distance of basin.
- **B** = misura interasse lavabo da destra / right distance of basin.
- **C** = misura totale del piano / total length of the shelf.
- verificare sempre che / verify that: **A + B + C = D.**