

## FY40PC + MW40SP Fly

Piano in cristallo extra\_light verniciato da cm 80 a 200 per lavabo Miniwash 40 sottopiano (staffe di fissaggio incluse)

Complementi: Lavabo Miniwash 40 (MW40SP)  
 Specchi e Lampade Make-Up  
 Specchi Simple  
 Specchio Hot/Cold (SPHC)  
 Specchio Left/Right (SPLR)  
 Specchi Line (BASC20 - BASC30 - BASC40)  
 Rubinetti lavabo linea ONE - NOKÈ - FOLD - SI - X1  
 Accessori linea TWO - HOOP - NOKÈ - FOLD

Accessori tecnici: Sifone cromo (SIFL/CR) - Sifone telescopico cromo (SIFL066)  
 Piletta Stop & Go (PLSG)  
 Piletta Stop & Go in ceramica (PLCE)  
 Set 2 pezzi rubinetto filtro cromo (RF026)

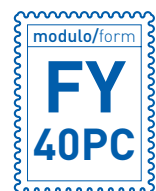
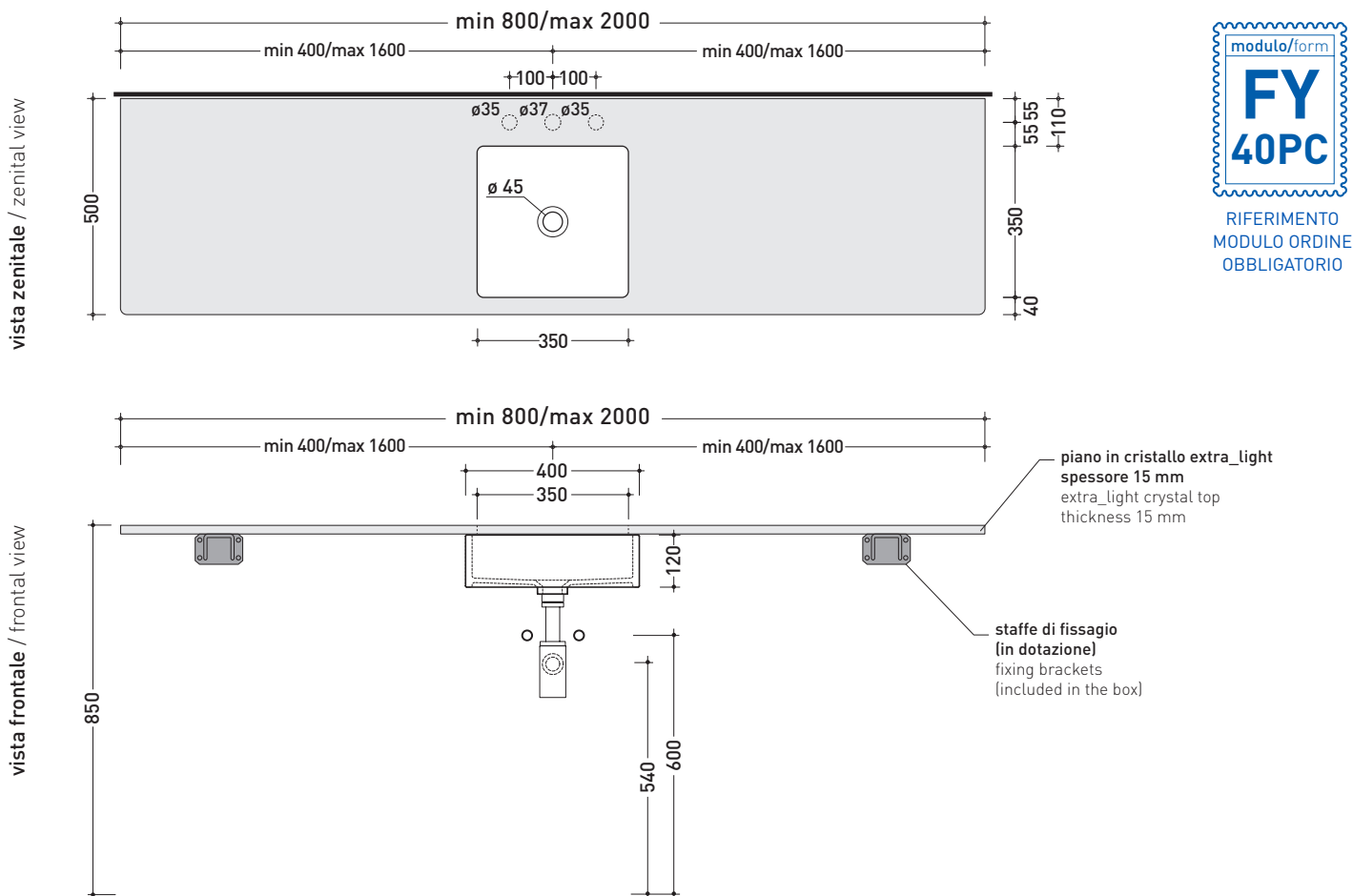

RIFERIMENTO  
 MODULO ORDINE  
 OBBLIGATORIO

dimensioni in mm

CRISTALLO: finiture lucide



bianco



nero

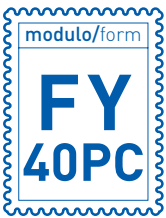

MODULO PER LA REALIZZAZIONE DEI PIANI IN CRISTALLO **FLY** A MISURA PER ART. **MW40SP**  
**FLY CUSTOMIZED CRYSTAL SHELVES FOR ART. MW40SP FORM**



**E' obbligatorio fotocopiare questa pagina, compilarla con cura e allegarla all'ordine.**  
 Is compulsory to photocopy this page, carefully fill in and attach to the order.

➔➔ **1** DETTAGLI ORDINE / ORDER DETAILS

ordinante - buyer \_\_\_\_\_ cliente - client \_\_\_\_\_

ordine - order n: \_\_\_\_\_ data - date: \_\_\_\_\_ ref.: \_\_\_\_\_

annotazioni - notes \_\_\_\_\_

➔➔ **2** SCELTA ARTICOLO / ITEM CHOICE

E' importante consultare prima la scheda tecnica relativa  
 It's important to consult before the technical detail

art. **FY40PC**  
 mensola / shelf da / from **80 a / to 200 cm**

➔➔ **3** SCELTA COLORE / COLOUR SELECTION

**CRISTALLO EXTRA\_LIGHT**  
 EXTRA\_LIGHT CRYSTAL

bianco - white  nero - black

➔➔ **4** SCELTA DETTAGLI / DETAILS SELECTION

FORI RUBINETTERIA / TAP HOLES

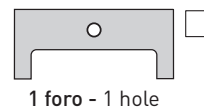
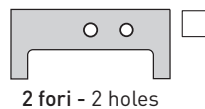
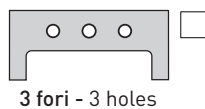

➔➔ **5** SCELTA MISURE / MEASURES

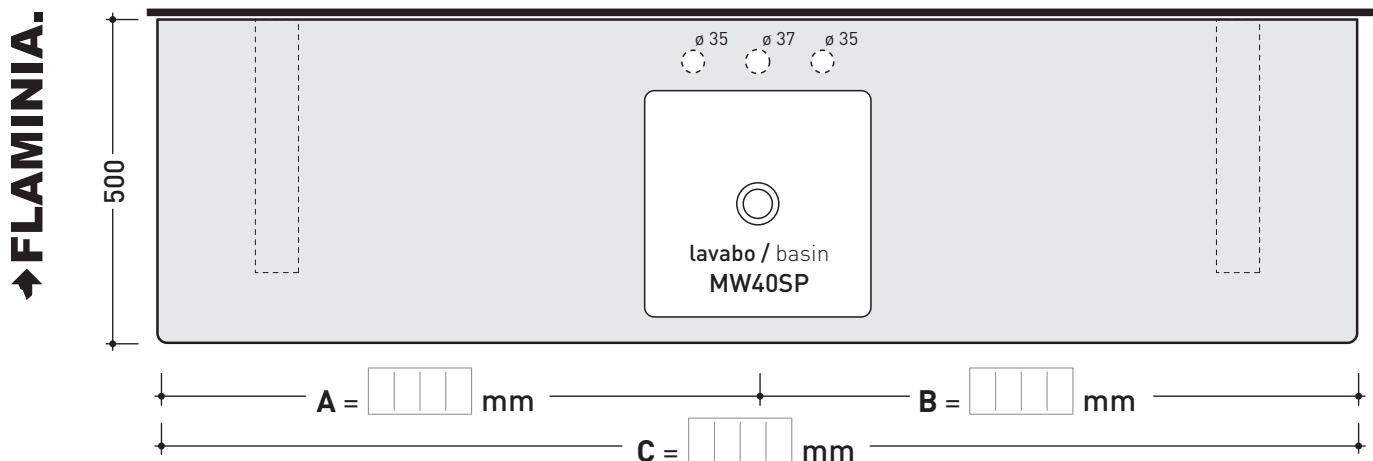

- **A** = misura interasse lavabo da sinistra / left distance of basin.
- **B** = misura interasse lavabo da destra / right distance of basin.
- **C** = misura totale del piano / total length of the shelf.
- verificare sempre che / verify that: **A + B = C**.

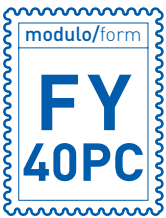

MODULO PER LA REALIZZAZIONE DEI PIANI IN CRISTALLO **FLY** A MISURA PER DOPPIO ART. **MW40SP**  
**FLY CUSTOMIZED CRYSTAL SHELVES FOR DOUBLE ART. MW40SP FORM**



**E' obbligatorio fotocopiare questa pagina, compilarla con cura e allegarla all'ordine.**  
 Is compulsory to photocopy this page, carefully fill in and attach to the order.

➔➔ **1** DETTAGLI ORDINE / ORDER DETAILS

ordinante - buyer \_\_\_\_\_ cliente - client \_\_\_\_\_

ordine - order n: \_\_\_\_\_ data - date: \_\_\_\_\_ ref.: \_\_\_\_\_

annotazioni - notes \_\_\_\_\_

➔➔ **2** SCELTA ARTICOLO / ITEM CHOICE

E' importante consultare prima la scheda tecnica relativa  
 It's important to consult before the technical detail

art. **FY40PC**  
 mensola / shelf da / from **140 a / to 200 cm**

➔➔ **3** SCELTA COLORE / COLOUR SELECTION

**CRISTALLO EXTRA\_LIGHT**  
 EXTRA\_LIGHT CRYSTAL

bianco - white  nero - black

➔➔ **4** SCELTA DETTAGLI / DETAILS SELECTION

**FORI RUBINETTERIA / TAP HOLES**

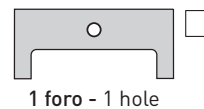
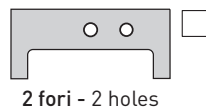
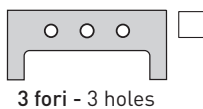

➔➔ **5** SCELTA MISURE / MEASURES

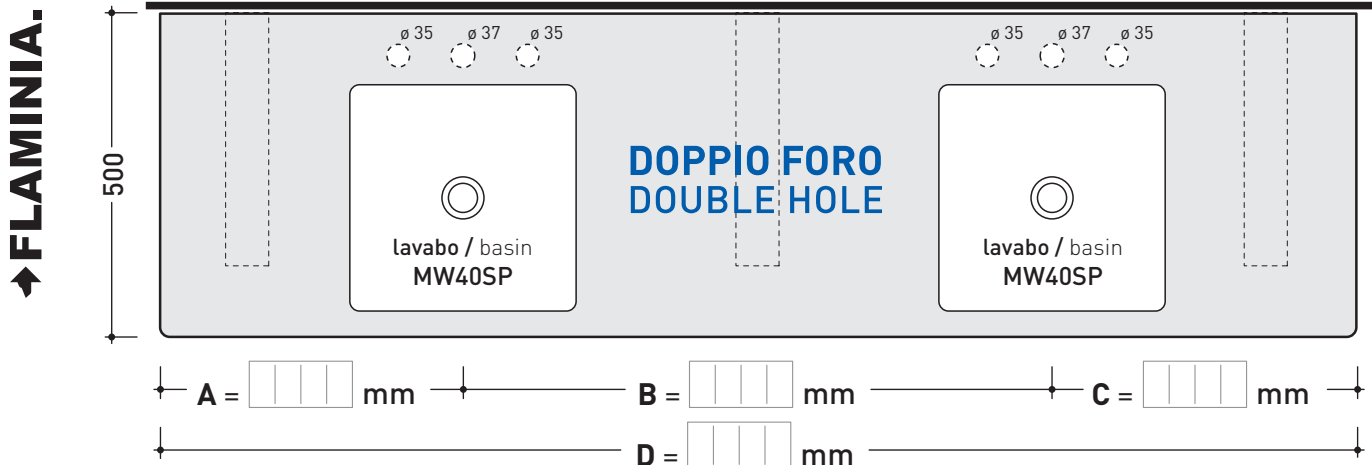
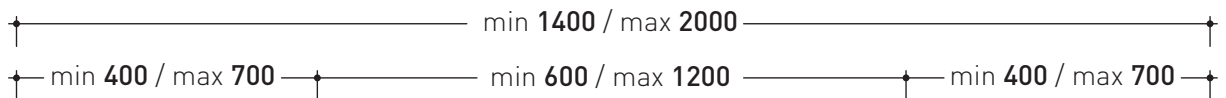

- **A** = misura interasse lavabo da sinistra / left distance of basin.
- **B** = misura interasse lavabo da destra / right distance of basin.
- **C** = misura totale del piano / total length of the shelf.
- verificare sempre che / verify that: **A + B + C = D.**