

design **LUDOVICA+ROBERTO PALOMBA**

2000

BASC20 Line 20

Reversible pivoting mirror 130x20 cm
(painted steel structure)

Package dim.	136 x 29 x 20 cm	Weight	6,2 kg	Pz. Pallet n°	-
--------------	------------------	--------	--------	---------------	---

BASC30 Line 30

Reversible pivoting mirror 130x30 cm
(painted steel structure)

Package dim.	136 x 39 x 22 cm	Weight	11 kg	Pz. Pallet n°	-
--------------	------------------	--------	-------	---------------	---

BASC40 Line 40

Reversible pivoting mirror 130x40 cm
(painted steel structure)

Package dim.		Weight		Pz. Pallet n°	-
--------------	--	--------	--	---------------	---



CE

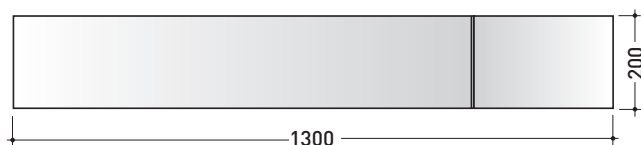

vista frontale / frontal view

BASC20

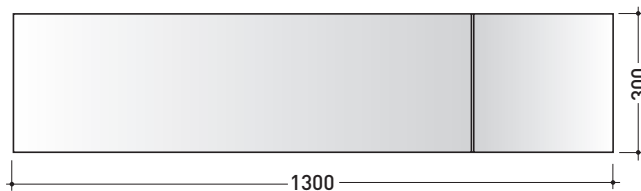

vista frontale / frontal view

BASC30

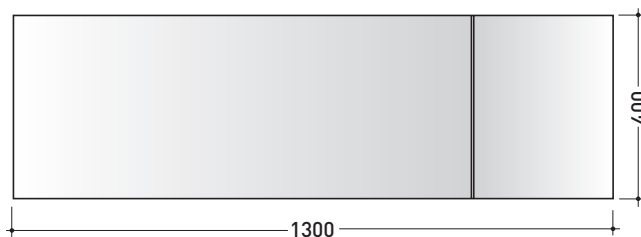

vista frontale / frontal view

BASC40

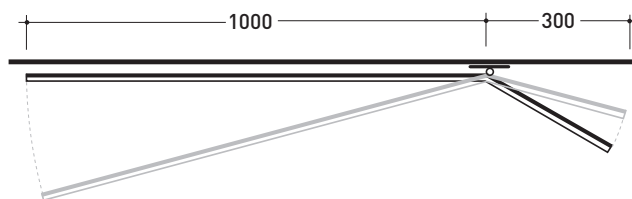

vista zenitale / zenital view

sizes in mm

<http://www.ceramicaflaminia.it/en/products/316-specchi>

©ceramicaflaminiaspa - All rights reserved. Unauthorized copying, publication, reproduction as well as partial reproduction are prohibited

april 2017



design LUDOVICA+ROBERTO PALOMBA

2000

SPAL

Corner mirror cabinet with light - door with right hinge
(painted steel structure)

Complements: UNA furnishing
COMONO SYSTEM furnishing
FORTY6- SOLID shelves

Package dim. 90 x 47 x 27 cm | Weight 10 kg | Pz. Pallet n° -

CE

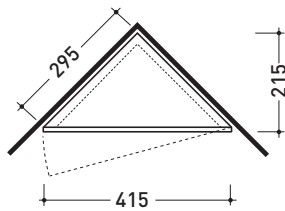

vista zenitale / zenital view

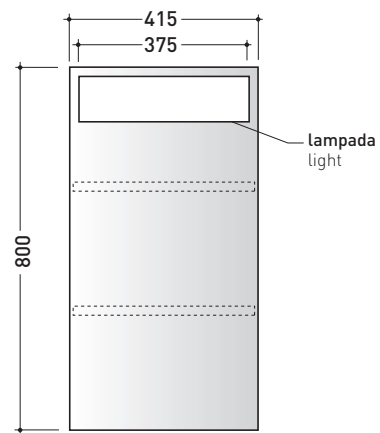

vista frontale / frontal view

sizes in mm

ELECTRICAL CHARACTERISTICS

- type of lamp: Neon G24q
- class: A
- Ip code: IP44
- rated power: 26 W

<http://www.ceramicaflaminia.it/en/products/316-specchi>

©ceramicaflaminiaspa - All rights reserved. Unauthorized copying, publication, reproduction as well as partial reproduction are prohibited

april 2017

Left / Right

➔ **FLAMINIA.**

design **LUDOVICA+ROBERTO PALOMBA**

2000

SPLR

Mirror cabinet with extractable compartments
(painted steel structure)

Complements: UNA furnishing
COMPONO SYSTEM furnishing
FORTY6 - SOLID shelves

Package dim. **80 x 72 x 18 cm** | Weight **18 kg** | Pz. Pallet n° -



CE

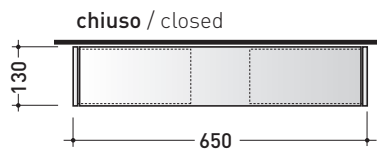

chiuso / closed

vista zenitale / zenital view

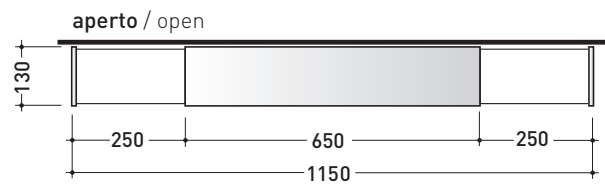

aperto / open

vista zenitale / zenital view

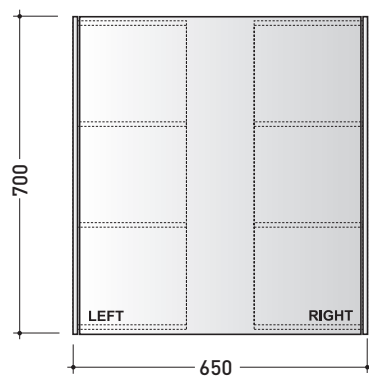

vista frontale / frontal view

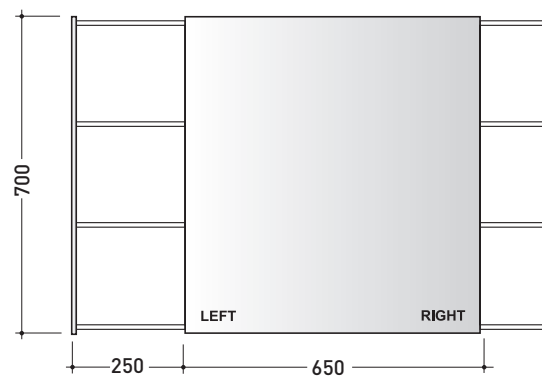

vista frontale / frontal view

sizes in mm

<http://www.ceramicaflaminia.it/en/products/316-specchi>

©ceramicaflaminiaspa - All rights reserved. Unauthorized copying, publication, reproduction as well as partial reproduction are prohibited

april 2017



Hot / Cold

➔ **FLAMINIA.**

design **LUDOVICA+ROBERTO PALOMBA**

2000

SPHC

Mirror with lamp and tap holes - taps not included
(painted steel structure)

Complements: ONE double-lever basin mixer (113060 + extensions art. PR65)
UNA furnishing
COMPONO SYSTEM furnishing
FORTY6- SOLID shelves

Package dim. 111 x 54 x 9 cm | Weight 8,5 kg | Pz. Pallet n° -



CE

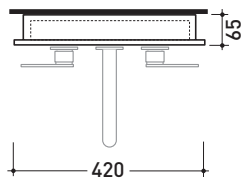

vista zenitale / zenital view

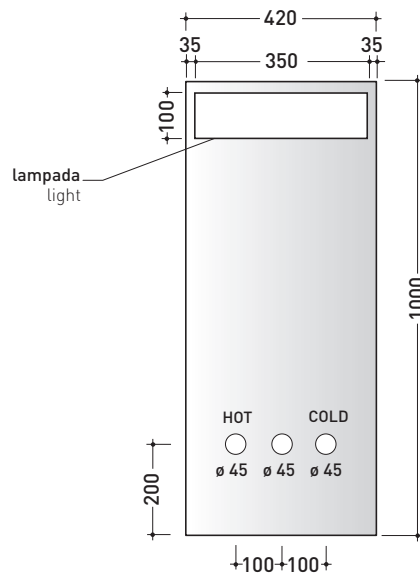

vista frontale / frontal view



vista frontale / frontal view

sizes in mm

ELECTRICAL CHARACTERISTICS

- type of lamp: Neon RX-L
- class: B
- Ip code: IP44
- rated power: 24 W

<http://www.ceramicaflaminia.it/en/products/316-specchi>

©ceramicaflaminiaspa - All rights reserved. Unauthorized copying, publication, reproduction as well as partial reproduction are prohibited

april 2017



NDS70

Reversible mirror 70x70 cm with integrated lighting

Package dim. 80 x 80 x 13 cm | Weight 10 kg | Pz. Pallet n° -

NDS90

Reversible mirror 90x90 cm with integrated lighting

Package dim. 100 x 97 x 13 cm | Weight 16 kg | Pz. Pallet n° -

Complements: UNA furnishing
COMPONO SYSTEM furnishing
FORTY6- SOLID shelves

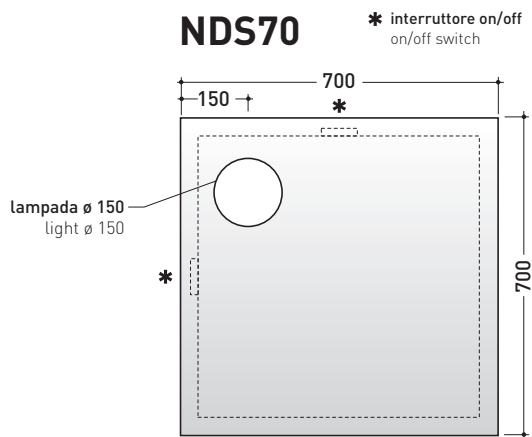

vista frontale / frontal view



vista zenitale / zenital view

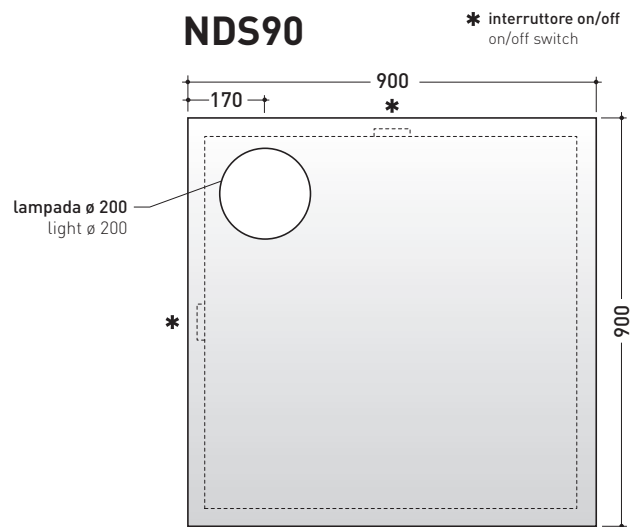

vista frontale / frontal view



vista zenitale / zenital view

sizes in mm

ELECTRICAL CHARACTERISTICS

- type of lamp: **alogen lamp R7s**
- class: **D**
- Ip code: **IP44**
- rated power: **48 W**

NDS120D

Reversible mirror 120x60 cm with right integrated lighting

Package dim. 128 x 71 x 13 cm | Weight 15 kg | Pz. Pallet n° -

NDS120S

Reversible mirror 120x60 cm with left integrated lighting

Package dim. 128 x 71 x 13 cm | Weight 15 kg | Pz. Pallet n° -

Complements: UNA furnishing
COMPONO SYSTEM furnishing
FORTY6- SOLID shelves



CE

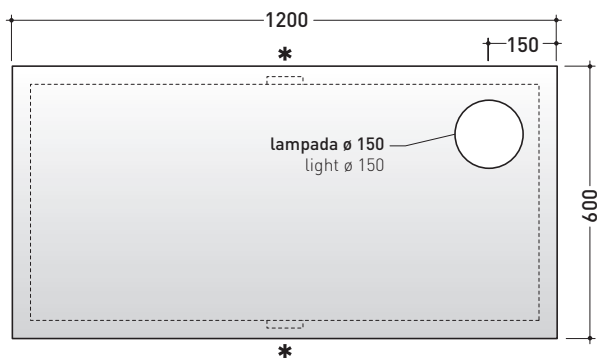

vista frontale / frontal view

NDS120D

* interruttore on/off
on/off switch

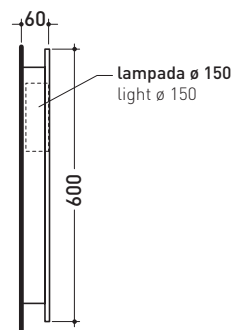

vista laterale / lateral view

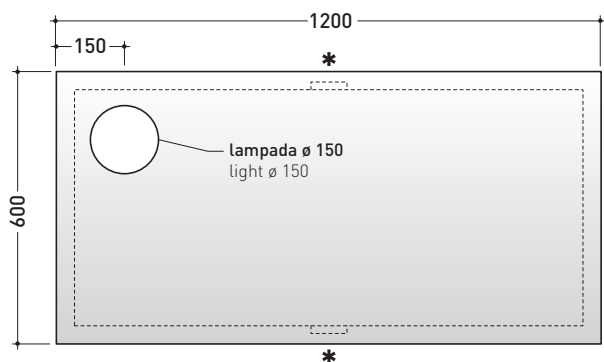

vista frontale / frontal view

NDS120S

* interruttore on/off
on/off switch



vista zenitale / zenital view

sizes in mm

ELECTRICAL CHARACTERISTICS

- type of lamp: **alogen lamp R7s**
- class: **D**
- Ip code: **IP44**
- rated power: **48 W**

NDS150

Reversible mirror 150x30 cm with integrated lighting
(horizontal and vertical installation)

Package dim. 128 x 71 x 13 cm | Weight 15 kg | Pz. Pallet n° -

NDS180

Reversible mirror 180x30 cm with integrated lighting
(horizontal and vertical installation)

Package dim. 128 x 71 x 13 cm | Weight 15 kg | Pz. Pallet n° -

Complements: UNA furnishing
COMONO SYSTEM furnishing
FORTY6- SOLID shelves

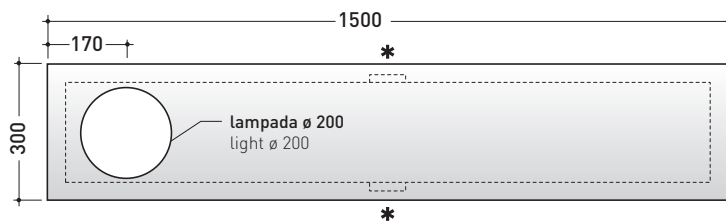

vista frontale / frontal view

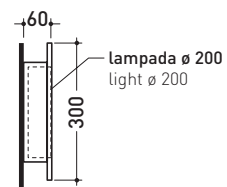

vista laterale / lateral view



vista zenitale / zenital view

NDS150

* interruttore on/off
on/off switch

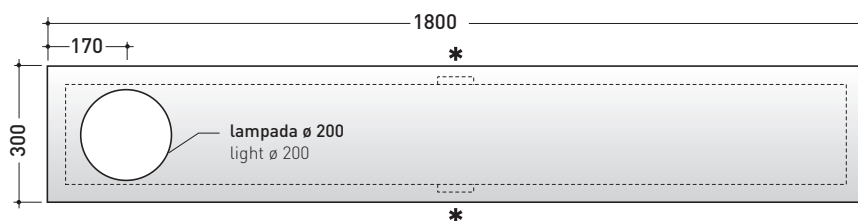

vista frontale / frontal view

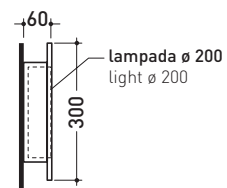

vista laterale / lateral view



vista zenitale / zenital view

NDS180

* interruttore on/off
on/off switch

sizes in mm

ELECTRICAL CHARACTERISTICS

- type of lamp: alogen lamp R7s
- class: D
- Ip code: IP44
- rated power: 48 W